

Nakamichi MR-2

2 Head Professional Cassette Deck
Owner's Manual

Controls and Features

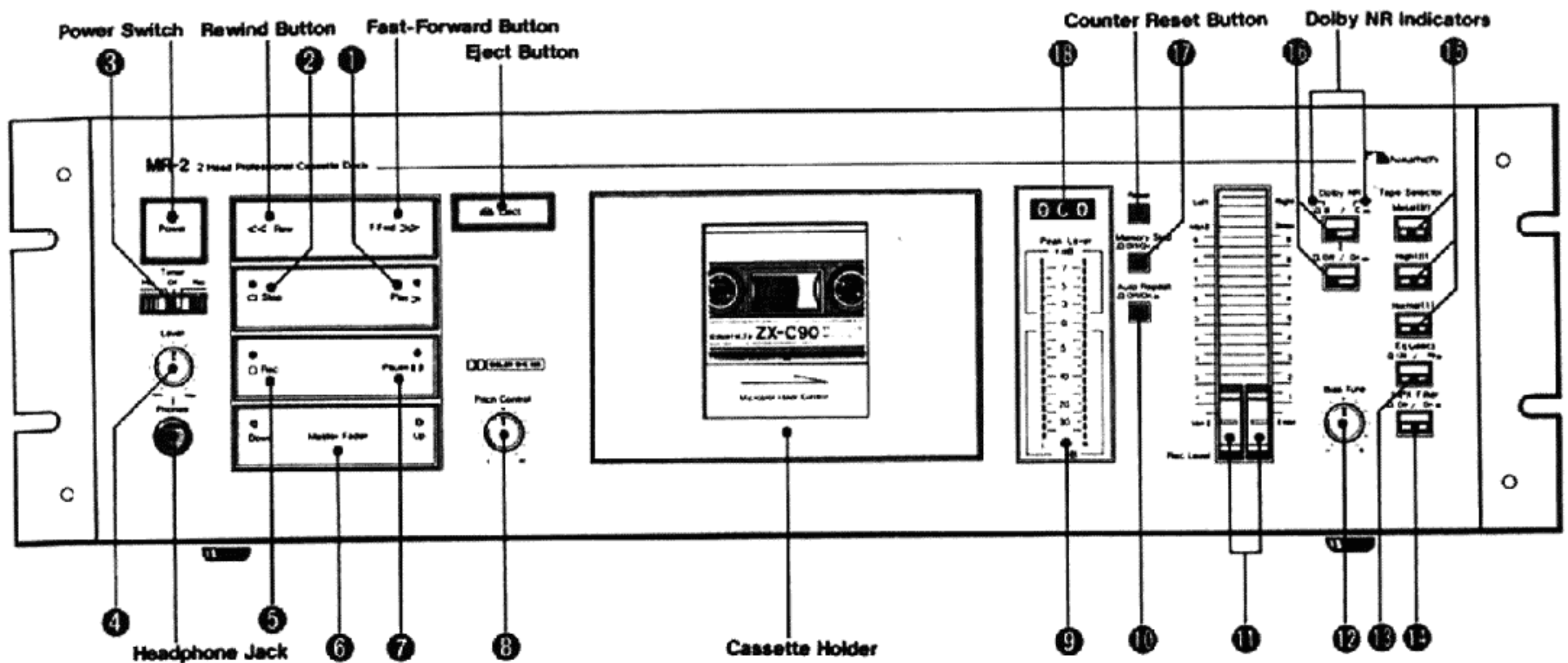

(1) Play Button

To start playback of a tape or start recording from the record-standby mode, press the section marked with >. During operation, the indicator lights up.

(2) Stop Button

When the section marked with □ is pressed, tape motion comes to a full stop and the indicator lights up.

(3) Timer Switch

This switch is used for timer-activated recording or playback. In ordinary operation, it must be set to "Off". (→p. 8)

(4) Headphone Level Control

This control permits adjustment of headphone listening level, independent from the line output level.

(5) Record Button

Simply by pressing the section marked with ○, the record-standby mode is entered, and the indicator lights up.

(6) Master Fader Button

This button is used to perform fade-in or fade-out during recording. (→p. 7)

(7) Pause Button

When the section marked with □□ is pressed during recording or playback, tape motion is interrupted and the indicator lights up. To restart the tape, press the Play button.

(8) Pitch Control

Serves to alter tape speed during playback over a range of approx. ±6% (one semitone).

(9) Peak Level Meters

Provide exact indication of peak levels in the range of -30 dB to +7 dB.

(10) Auto Repeat Switch

By setting this switch to "On", auto repeat playback is performed. (→p. 8)

(11) Input Level Controls

Serve to adjust the recording level for left and right channel.

(12) Bias Tune Control

Serves for fine adjustment of the bias current. (→p. 7)

(13) Equalizer Switch

Serves to set the correct equalization in recording and playback for the tape in use. (→p. 7)

(14) MPX Filter Switch

Used to suppress the 19-kHz multiplex carrier signal, which could interfere with proper Dolby NR operation when recording from FM stereo broadcasts. When recording from other sources or during playback, this switch should be set to "Off".

(15) Tape Selector Switches

In recording, the correct switch must be pressed for the tape in use. (→p. 7)

(16) Dolby NR Switches

To use the Dolby noise reduction system, set the lower switch to "On" and select either the B-type or the C-type system with the upper switch. The respective Dolby NR indicator lights up.

(17) Memory Switch

When this switch is set to "On", the tape automatically stops at the counter indication "000" during rewind.

(18) Tape Counter

Indicates tape travel, starting from "000". By pressing the Counter Reset button, the counter is reset to "000".

(19) 1/4-Inch Line Input Jacks (Unbalanced)

The nominal input level of these jacks is -10 dBV (0.316 V), and nominal input impedance 50 kohms (minimum).

(20) RCA Type Line Input Jacks (Unbalanced)

The nominal input level of these jacks is -10 dBV (0.316 V), and nominal input impedance 50 kohms (minimum).

(21) Copy Out Terminals

The signal from the RCA type line input jacks is supplied directly at these terminals, without being routed through the deck's preamplifier circuits. This is useful for example to record simultaneously on more than one deck (duplicating). (→p. 6)

(22) RCA Type Line Output Jacks (Unbalanced)

The nominal output level of these jacks is -10 dBV (0.316 V), and nominal load impedance 50 kohms.

(23) 1/4-Inch Line Output Jacks (Unbalanced)

The nominal output level of these jacks is -10 dBV (0.316 V), and nominal load impedance 50 kohms.

(24) Line Output Level Control

Serves to adjust the line output level. The output level at the 0-dB indication of the deck's built-in peak level meters is 0.316 V (-10 dBV) when this control is turned to minimum, and 1.228 V (corresponding to about +4 dBm balanced) when the control is turned to maximum.

Connections

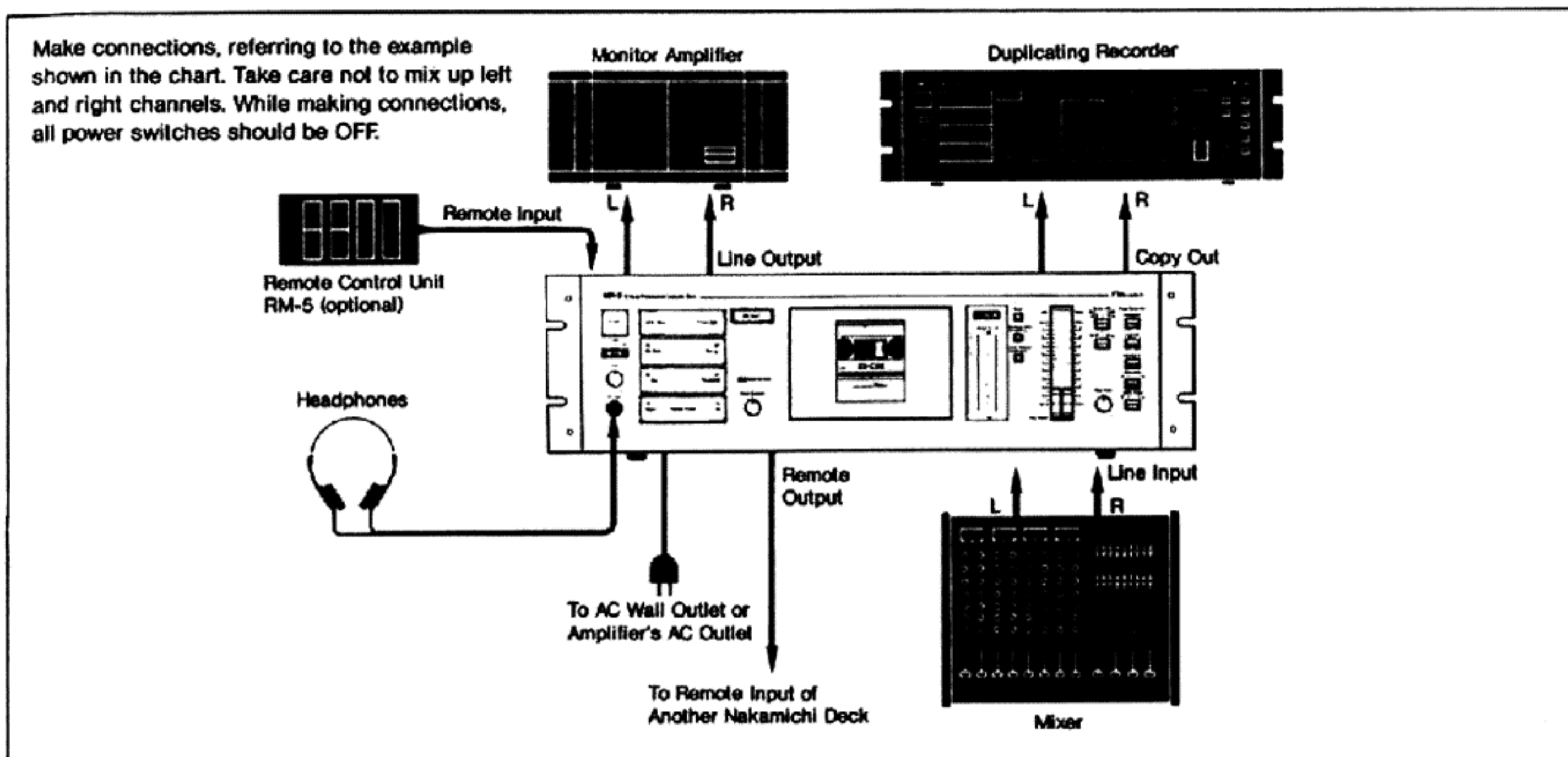

Headphones

Standard stereo headphones with an impedance of 8–150 ohms may be connected to the headphone jack.

Remote Control

The optional remote control unit RM-5 permits operation of the deck's tape transport functions from any convenient location.

Line Input Terminals

This cassette deck provides two complete sets of input and output terminals on the rear panel. The 1/4-inch input/output jacks are given priority over the RCA type jacks. Therefore only the signal carried at the 1/4-inch jacks will be led in or out when both sets of terminals are used simultaneously.

Copy Out Terminals

These jacks are wired in parallel with the RCA type line input terminals. Therefore the signal applied to the RCA type input can be fed to other equipment without being routed through this deck's preamplifier circuits. This is very useful for example when recording the same signal on more than one deck (duplicating), as only one output from the recording source (mixing console etc.) will be needed. However, if the 1/4-inch line input is used, the RCA type input is cut off and the signal from the 1/4-inch input does not appear at the Copy Out terminals.

Remote Control Output Terminal

When the optional remote control unit RM-5 is used to operate the tape transport of the MR-2, this terminal permits routing the control signals to the remote control input of another Nakamichi cassette deck for synchronous operation. Use the supplied 8p connectors for this connection.

On Impedance

All electrical components as well as connector cables etc. have a certain resistance. The amount of resistance against alternating current is called impedance. If input and output impedance do not match, a loss in signal level occurs and sound quality may deteriorate. In extreme cases, overheating and even damage to connected equipment may result. Therefore it is important to carefully consider input and output impedances when connecting this cassette deck to other devices. It is generally accepted that output impedance should be as low as possible to keep voltage losses and signal deterioration with multiple equipment connections to a minimum. Reversely, input impedance can be said to be the higher the better, because audio components are usually designed in such a way that their internal circuits are driven correctly by low currents. **When making connections, it is absolutely imperative that the impedance on the input side always be higher than that of the source.**

Precautions Before Operation

- (1) This deck incorporates a muting circuit which is active for about 4 seconds after the power was switched on, until all circuits have become stable.
- (2) If the power is switched on while the Timer switch is set to "Rec" or "Play", recording or playback will start automatically. In order to prevent accidental erasure of a tape, be sure to set the Timer switch to "Off" when the timer function is not desired.
- (3) If during playback or recording the power

to the deck was switched off by an external timer or the like, it may afterwards not be possible to depress the Eject button. Do not apply excessive force in such a case. Set the Timer switch of the deck to "Off", and then switch the power to the deck back on. The cassette can now be removed.

(4) Voltage Selector

AC voltage is factory-set for the country in which you purchased your cassette

deck. The voltage selector permits re-setting of mains voltage in case the deck is to be used in a different country.

Note:

Safety regulations in certain countries prohibit inclusion of a voltage selector. This feature, therefore, may be absent from your deck.

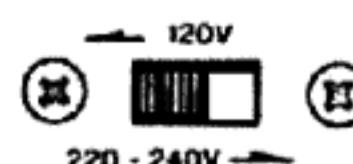

Operation

Playback

- (1) Set the Equalizer switch to the required position for the tape in use.
- (2) Set the Dolby NR switches to the same position as used for recording.
- (3) Press the Play button.
- (4) Adjust the desired listening level with the Line Output or Headphone Level control.
 - During playback, this deck's Peak Level

meters display the level recorded on the tape. Readings are not affected by turning the Output Level control.

- With this deck you can go from any mode into any other (for example from playback to rewind, from rewind to fast-forward, etc.) without having to press the Stop button.

Recording

- (1) Set the Tape Selector switches and the Equalizer switch to the required positions for the tape in use.
- (2) Select the desired position of the Dolby NR switches. For recording from FM broadcasts, set the MPX Filter switch to "On".
- (3) Simply press the Rec button to set the deck to the record-standby (Rec/Pause) mode.
- (4) Set the recording level with the Input Level controls, while watching the indication of the Peak Level meters.

- (5) Press the Play button to start recording. To temporarily stop the tape while remaining in the record-standby mode, press the Pause button. To resume recording, press the Play button once more.

Record Level Setting

For good recordings, it is essential to maintain a high signal-to-noise ratio. If the record level is set too low, tape hiss will impair the playback sound quality. If it is set too high, the tape will be driven into distortion. Refer to the chart below to set recording levels.

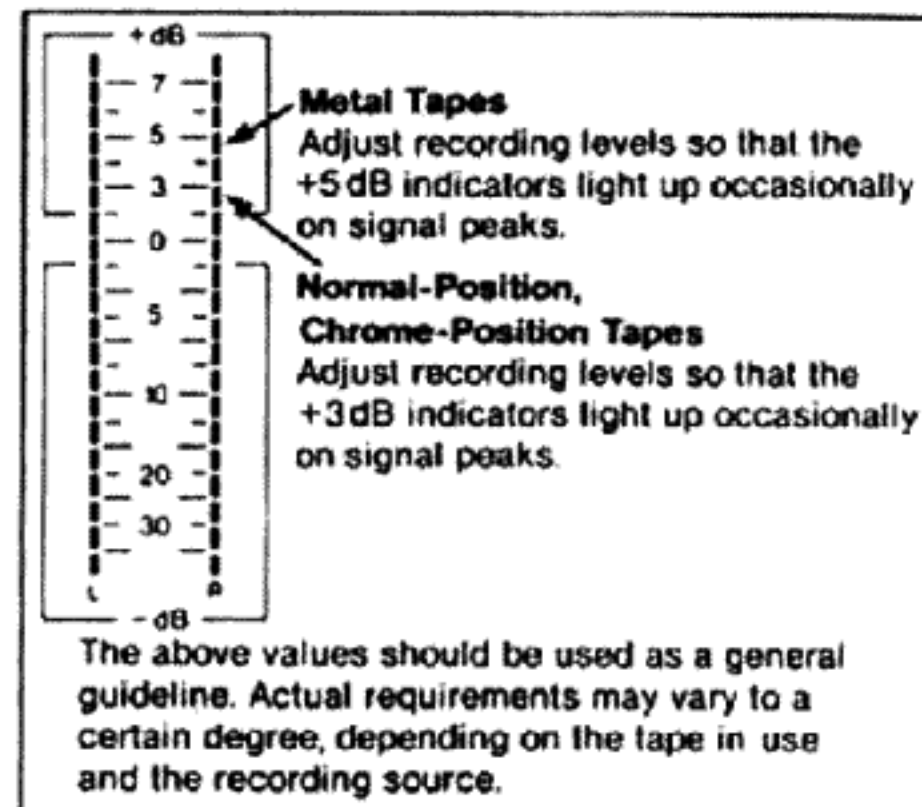

Tape Selector and Equalizer Switch Setting Chart

Tape Selector	Eq (μ sec)	Brand/Designation
Normal Position Normal	120 μ sec	Nakamichi EX II Fuji FR-I, GT-I Maxell XL I, XL I-S TDK AD, AD-X
Chrome (Cobalt) Position High	70 μ sec	Nakamichi SX, SX II Fuji FR-II, GT-II Maxell XL II, XL II-S TDK SA, SA-X
Metal Position Metal	70 μ sec	Nakamichi ZX Fuji FR Metal Maxell MX TDK MA, MA-R

This cassette deck was calibrated at the factory with Nakamichi reference tapes. To obtain optimum results and fully realize this deck's potential, the use of Nakamichi tapes is recommended. When using other tapes, you should choose tapes from the list, whenever possible.

Bias Tune Control

This deck provides a Bias Tune control which permits fine adjustment of the bias current after the standard values have been set with the Tape Selector switches. Reducing the bias current extends high-frequency response, but distortion tends to increase. Conversely, increasing the bias current reduces distortion but curtails high-frequency response. When using tapes from the above list, the Bias

Tune control should be left in the center click-stop position. When using other tapes, adjust the bias while comparing the sound of the input signal and the recorded signal. This comparison can best be done by recording FM interstation noise or a similar signal at about -30 dB to -20 dB, rewinding the tape, and comparing the sound during playback to the original input signal.

- (1) If the recorded signals sounds brighter than the original source, turn the Bias Tune control the right (+).
- (2) If the recorded signal sounds duller than the original source, turn the Bias Tune control to the left (-).
- (3) By repeating the above steps, adjust the Bias Tune control to minimize any sound quality differences.

■ Dolby NR System

This cassette deck provides a choice between the Dolby B-type and the Dolby C-type noise reduction systems. The Dolby B-type NR provides approximately 10 dB of noise reduction in the high frequencies. The Dolby C-type NR is a further refined system, which achieves a S/N ratio improvement of about 20 dB in the range from 2 kHz to 8 kHz, where noise is most readily audible.

For playback of a tape which was recorded with the B-type NR, set the Dolby NR switch to "B". For playback of a tape recorded with Dolby C-type NR, set the switch to "C".

■ Timer Recording or Playback

(1) Establish connections as shown in the chart, and switch on the power to all components.

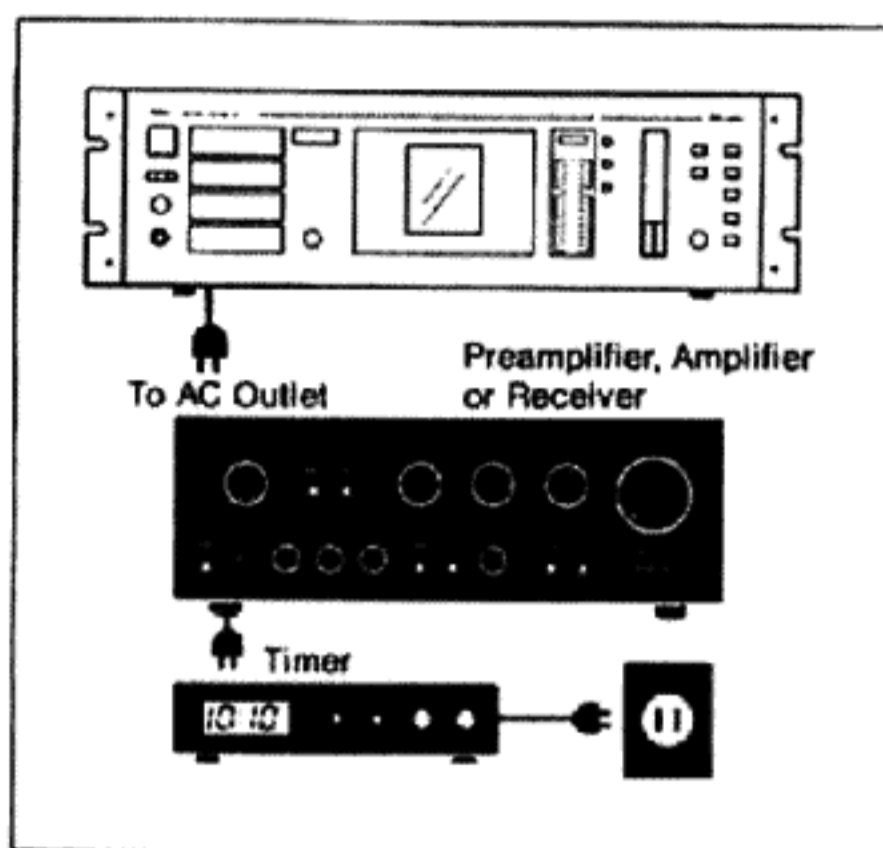

- (2) For timer-activated recording, set the recording level to suit the expected signal. For timer-activated playback, set the Output control to the desired level.
- (3) For timer-activated recording, set this deck's Timer switch to "Rec". For timer-activated playback, set the switch to "Play".
- (4) Set the timer to the desired operation time.
- (5) At the pre-selected time, the timer will supply power to the components, and recording or playback will start automatically.

Notes:

- Be sure to set this deck's Timer switch to "Off" when timer recording or playback is not to be carried out.
- If the record-protection tabs of the inserted cassette are removed, timer-activated recording is not possible and the deck will go into the stop mode.

Special Features

1. Master Fader

This feature permits smooth and easy fades during recording without having to move the Input Level control. By pressing the "Down" section of the Master Fader button, the recording level is gradually reduced to zero. After the level was reduced by pressing "Down", pressing the "Up" section will automatically raise it again to the previous setting.

You can choose between two fading speeds. If you keep the button depressed, the fading is comparatively fast. If you release the button immediately after pressing it, the fading is slower. The respective fading mode is indicated by the brightness of the indicators.

Note:

- The operation of the fader control can be changed from "Up" to "Down" or from "Down" to "Up", but it cannot be stopped midway.
- The Master Fader is operative only in the record and record-standby modes. When these modes are released, the setting automatically becomes "Up".

2. Auto Repeat Playback

(1) Auto Repeat of One Complete Side

With the Auto Repeat switch set to "On", the following operating sequence is repeated when the tape end is reached during recording, playback or fast-forward:

automatic rewind to the tape start → playback from the beginning → automatic rewind when tape end is reached → playback from the beginning....

Repeat playback will also be performed if the beginning of the tape is reached in rewind.

(2) Auto Repeat Between Tape Counter "000" and Tape End

The auto repeat function can also be used in conjunction with the Memory switch. When the Auto Repeat switch and the Memory switch are both set to "On", auto repeat will be performed between the tape counter "000" indication and the tape end.

- When the Timer switch is set to "Rec" or "Play", the auto repeat function is inoperative.

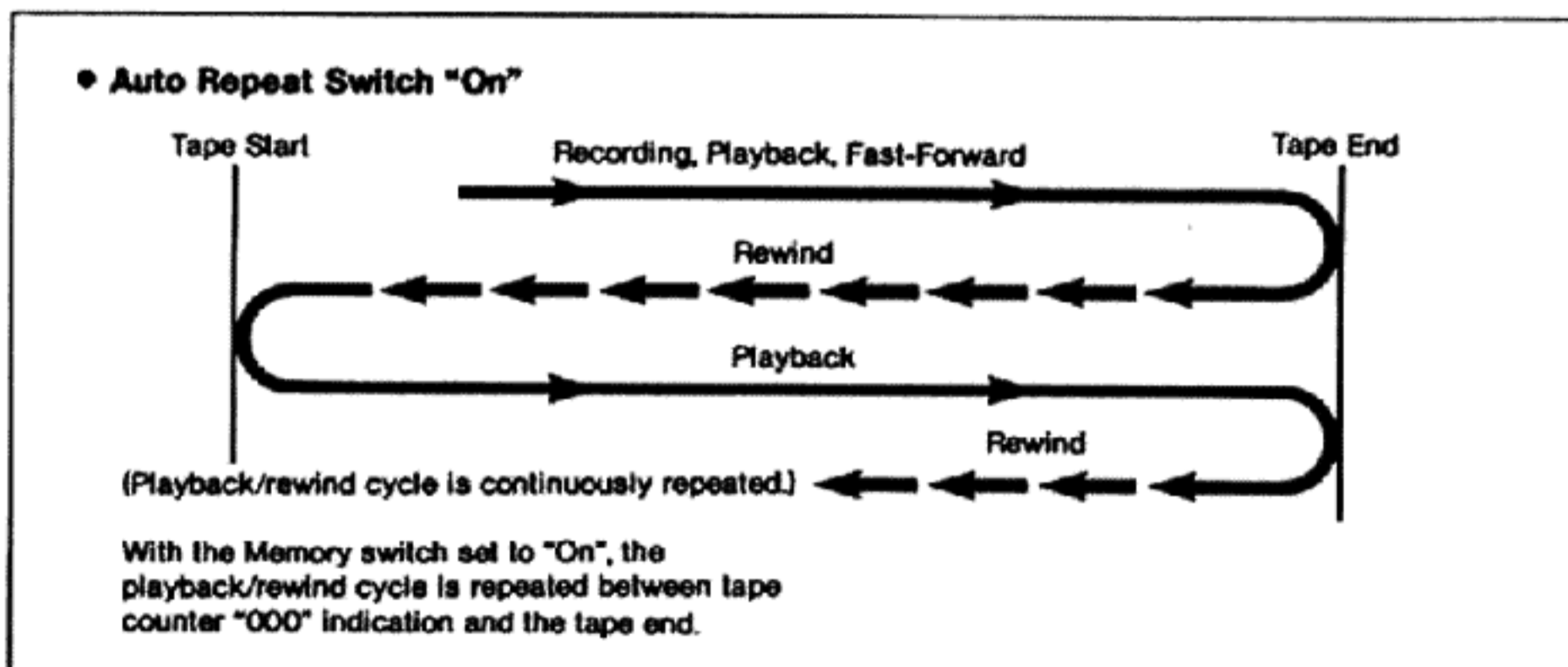

Maintenance

Cleaning

It is very important to regularly clean the head surfaces and transport section, etc. Contamination caused by liny particles shedded from the tape onto these parts can become the cause of drop-outs and severely degrade high-frequency response and wow-and-flutter characteristics. Perform cleaning about once every 10 hours of use.

(1) Remove the cassette holder cover and push the cassette holder back in.

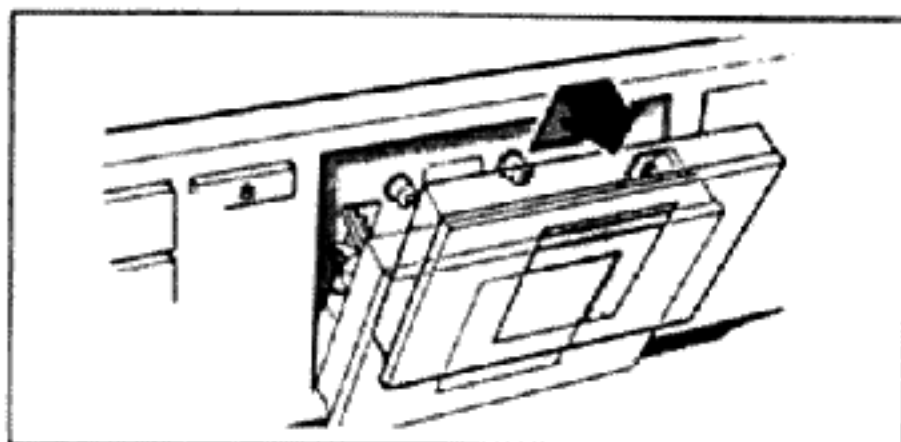

(2) Press the Play button and clean the revolving pressure roller by holding a cotton-tipped stick lightly against the roller on the side turning away from the capstan.

Be careful that the cotton tip does not get caught between the roller and the capstan.

(3) Press the Pause button to release the pressure roller from the capstan. Now clean the capstan and the surfaces of the heads and tape guides with a cotton-tipped stick. Be careful not to apply too much force. Take special care not to damage the tape guides.

- After cleaning, make sure that no cotton strands are left on any of the cleaned parts.
- In case of severe contamination, moisten the cotton tip with a small amount of commercially available cleaning fluid designed especially for this purpose. After cleaning with a cleaning fluid, wait until any residue has completely dried off before playing a tape.

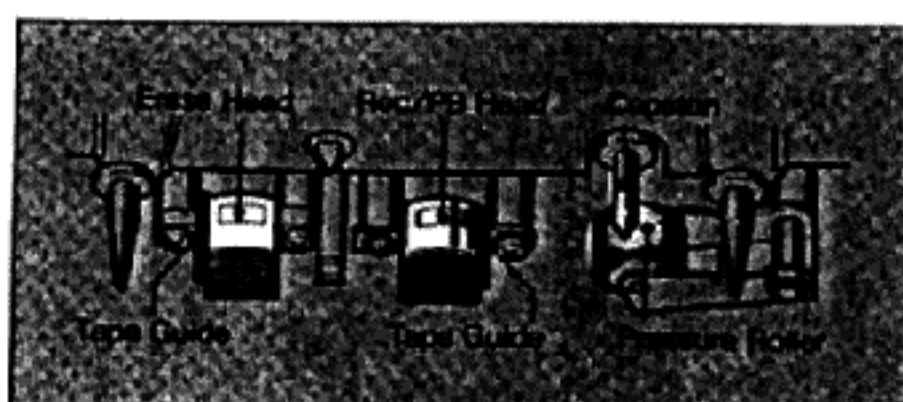

Demagnetizing

After a longer period of use, there can be a build-up of residual magnetism in the heads and capstan. Such residual magnetism can induce noise and partially erase the high frequencies of a tape being played. To prevent this, you should demagnetize these parts about once every 50 hours of use with the Nakamichi DM-10 Demagnetizer (optional) or any other properly designed demagnetizer. For details, refer to the instruction manual of the demagnetizer. Always switch the power to the deck off before using the demagnetizer.

Lubrication

All important moving parts of this cassette deck are fitted with long-life, oil-less bearings. Periodic lubrication is therefore not necessary.

Cleaning the Faceplate

Clean the faceplate only by wiping it with a soft, dry cloth. Never use alcohol, solvents, ammonia or abrasive cleaning agents.

Troubleshooting

Condition	Probable Cause	Remedy
Tapes does not run.	1. Cassette holder not completely locked.	1. Press Eject button and then close cassette holder firmly.
Record mode cannot be entered.	2. Cassette tabs have been removed.	2. Place adhesive tape over tab opening or use new cassette.
Excessive playback hiss.	3. Head is magnetized.	3. Demagnetize head.
Uneven sound levels, drop-outs, excessive wow/flutter.	4. Head and/or capstan and pressure roller dirty. 5. Faulty cassette.	4. Clean these parts. 5. Replace cassette.
Incomplete erasure.	6. Erase head dirty.	6. Clean head and pressure roller.
Distorted record/playback sound.	7. Program material itself is distorted. 8. Recording levels are too high. 9. Head dirty. 10. Wrong setting of Tape Selector switches.	7. Check program material. 8. Wide dynamic range permits some short-term overload, but excessive recording levels will cause distortion. Adjust recording levels. 9. Clean head. 10. Select correct setting for the tape in use.
Record mode is entered, but cannot record.	11. Head dirty. 12. Master fader control is set to down.	11. Clean head. 12. Push the "Up" side of the master fader button.
Cannot playback.	13. Output disconnected. 14. Head dirty.	13. Check connections. 14. Clean head.
Dull high frequencies.	15. Head dirty. 16. Tape Selector switches and/or Equalizer switch not set correctly.	15. Clean head. 16. Select correct positions for tape in use.
Hum heard during recording or playback.	17. Strong induction fields near deck. 18. Signal cable or connector grounding faulty.	17. Keep deck away from amplifiers, transformers, fluorescent lamps, etc. 18. Replace signal cables.

Block Diagram

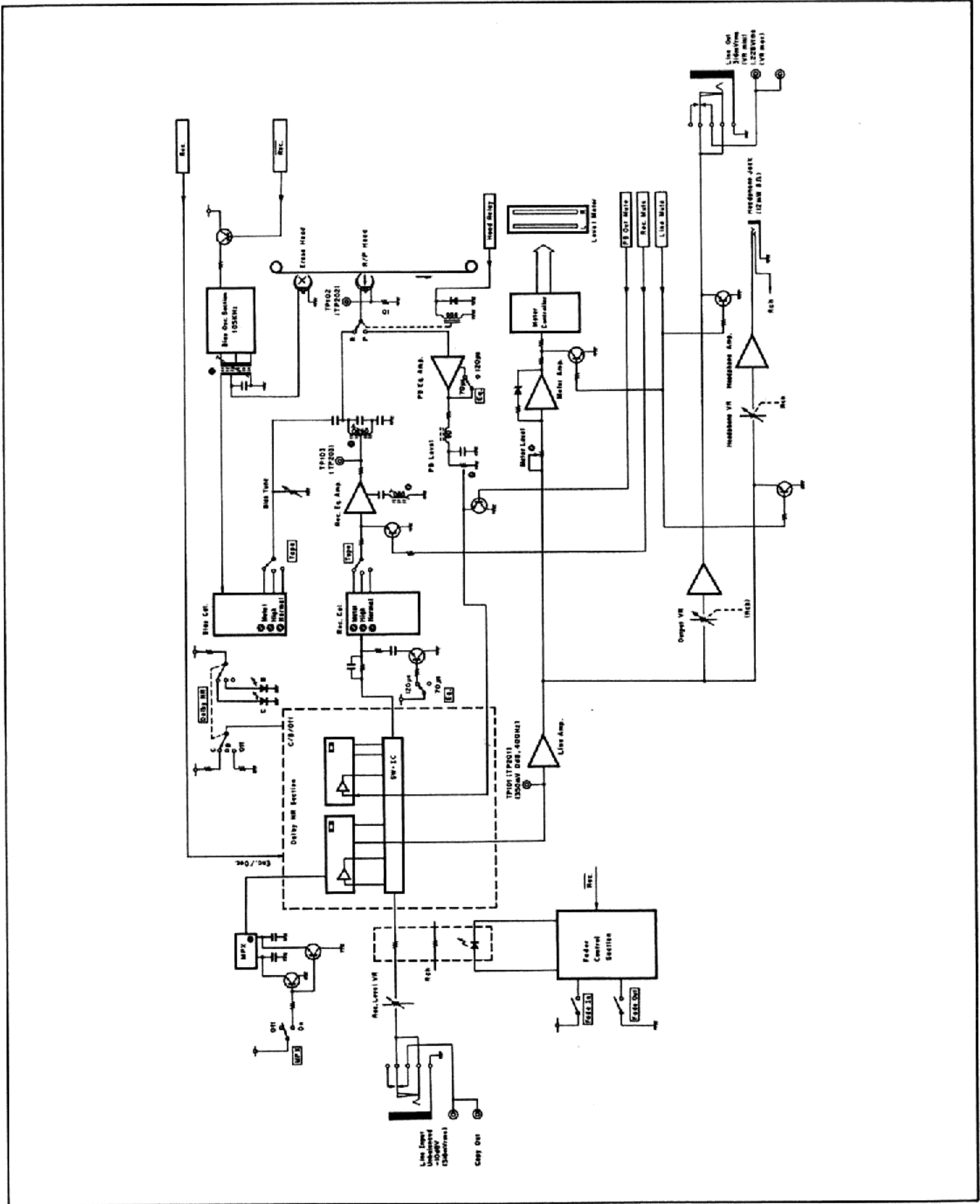

Specifications

Track Configuration.....	4 tracks/2-channel stereo
Heads.....	2 (erase head x 1, record/playback head x 1)
Motors (Tape Transport).....	DC servo motor (capstan drive) x 1 DC motor (reel drive) x 1
Power Source.....	120 V AC, 50/60 Hz
Power Consumption.....	23 W max.
Tape Speed.....	1-7/8 ips. (4.8 cm/sec.) ± 0.5%
Wow-and-Flutter.....	Less than ± 0.11% WTD Peak Less than 0.06% WTD RMS
Frequency Response.....	20 Hz—20,000 Hz (recording level - 20 dB, ZX, SX, EXII tape)
Signal-to-Noise Ratio.....	Dolby C-Type NR on < 70 μs, ZX tape > Better than 68 dB (400 Hz, 3% THD, IHF A-WTD RMS) Dolby B-Type NR on < 70 μs, ZX tape > Better than 62 dB (400 Hz, 3% THD, IHF A-WTD RMS)
Total Harmonic Distortion.....	Less than 1.0% (400 Hz, 0 dB, ZX, EXII tape) Less than 1.2% (400 Hz, 0 dB, SX tape)
Erasure.....	Better than 60 dB (100 Hz, + 10 dB)
Separation.....	Better than 38 dB (1 kHz, 0 dB)
Crosstalk.....	Better than 60 dB (1 kHz, 0 dB)
Bias Frequency.....	105 kHz
Line Input (1/4-inch Type)	
Input Impedance.....	Min. 50 kohms (unbalanced)
Nominal Input Level.....	- 10 dBV (0.316 V)
Minimum Input Level.....	- 20 dBV (0.1 V)
Line Input (RCA Type)	
Input Impedance.....	Min. 50 kohms (unbalanced)
Nominal Input Level.....	- 10 dBV (0.316 V)
Minimum Input Level.....	- 20 dBV (0.1 V)

Line Output (1/4-inch Type)	
Output Impedance.....	2.2 kohms (unbalanced)
Nominal Load Impedance.....	More than 50 kohms
Nominal Output Level.....	- 10 dBV (0.316 V) VR Min. + 4 dBm (1.228 V) VR Max.
Output Saturation Level.....	+ 9.5 dBV (3.0 V)
Line Output (RCA Type)	
Output Impedance.....	2.2 kohms (unbalanced)
Nominal Load Impedance.....	More than 50 kohms
Nominal Output Level.....	- 10 dBV (0.316 V) VR Min. + 4 dBm (1.228 V) VR Max.
Output Saturation Level.....	+ 9.5 dBV (3.0 V)
Headphone Output.....	Max. 12 mV (with 8-ohm load)
Equalization (Switchable)	
Normal.....	3180 μs + 120 μs
High, Metal.....	3180 μs + 70 μs
Fast-Wind Time.....	Approx. 85 seconds (with C-60 cassette)
Dimensions.....	483 (W) x 132 (H) x 250 (D) millimetres 19 (W) x 5-3/16 (H) x 9-13/16 (D) inches
Approximate Weight.....	5.4 kg, 11 lb 14 oz

- In these specifications, 0 dBV is referenced to 1.0 volt. Actual voltage levels are given in parenthesis. To calculate the 0 dB = 0.775 volt reference level (i.e. 0 dBm in a 600-ohm circuit), add 2.2 dB to the listed dB value; for example, - 10 dB re 1 V = - 7.8 dB re 0.775 V.
- Specifications and design are subject to change for further improvement without notice.
- Noise Reduction System manufactured under license from Dolby Laboratories Licensing Corporation.
- The word "DOLBY" and the Double-D-Symbol are trademarks of Dolby Laboratories Licensing Corporation.

■ Filter Characteristics

MPX Filter

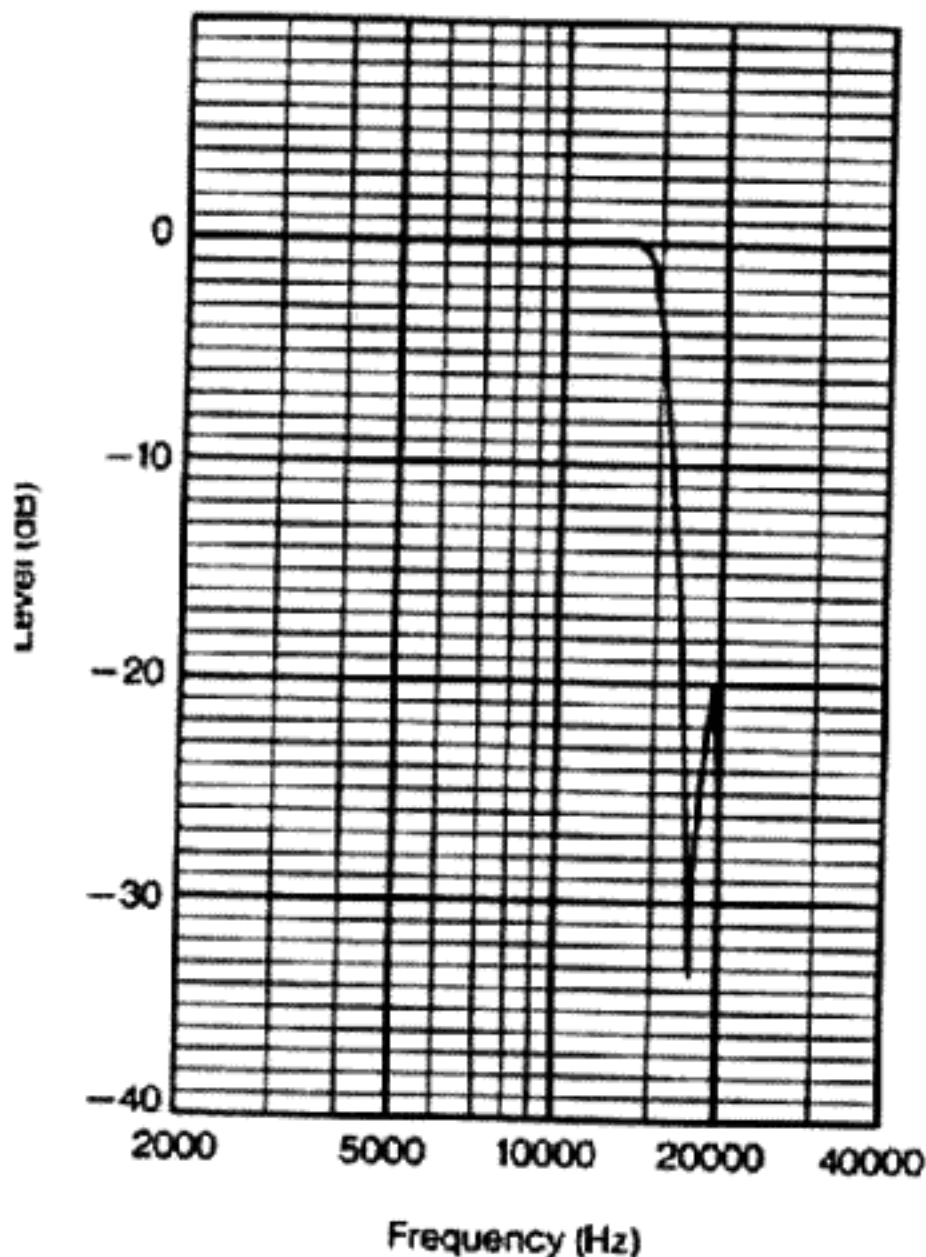

Optional Accessories

ZX Metalloy Cassette Tape
C-60, C-90
SX II Super Ferricobalt Cassette Tape
C-60, C-90
SX Ferricobalt Cassette Tape
C-60, C-90
EX II Ferricrystal Cassette Tape
C-60, C-90

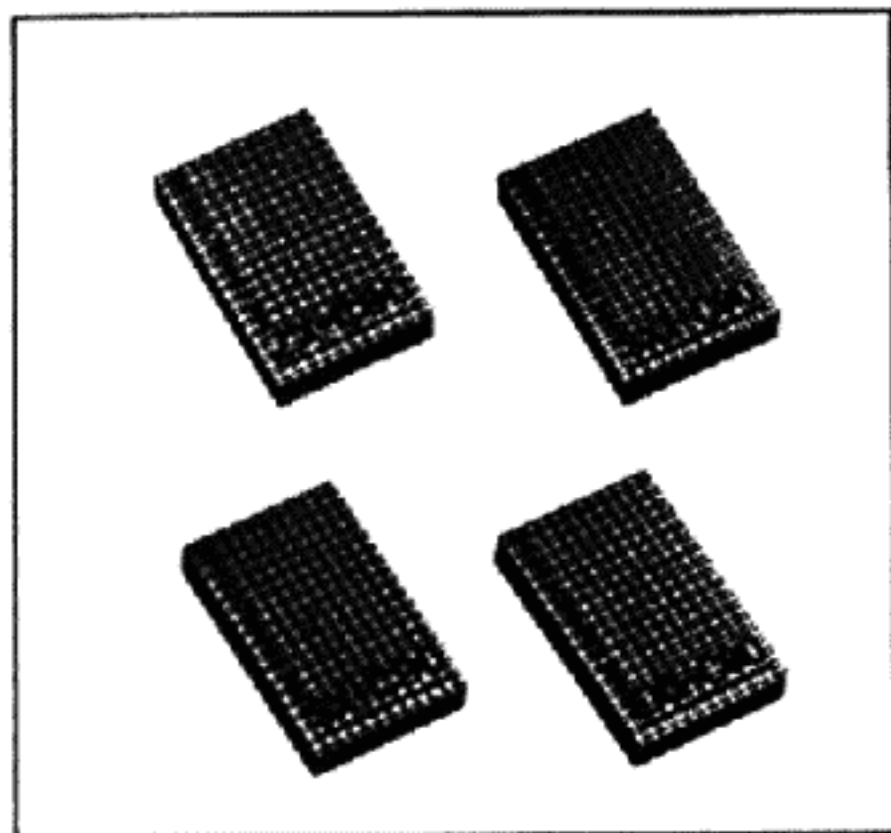

DM-10 Head Demagnetizer

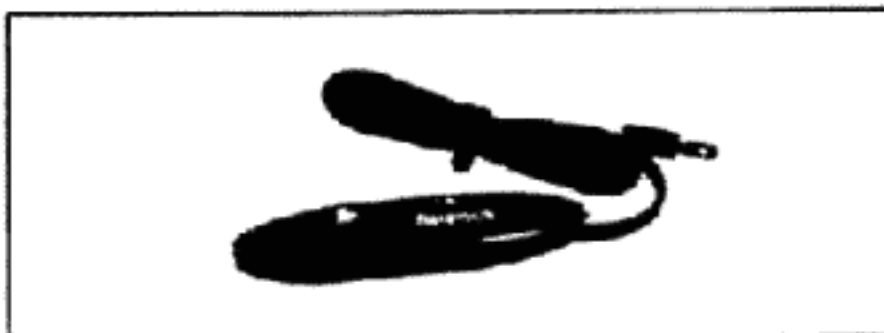

RM-5 Remote Control Unit

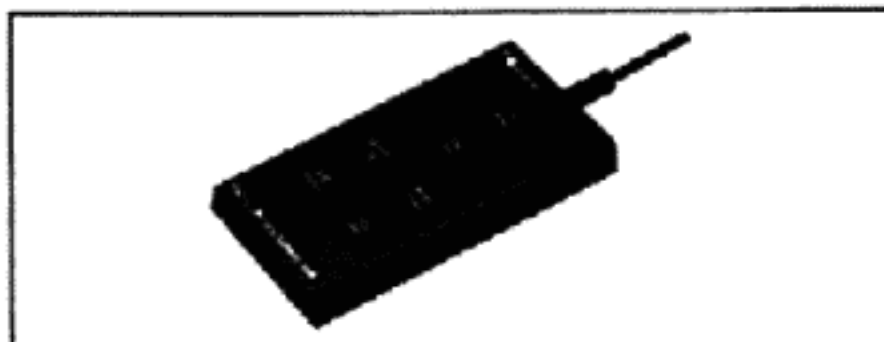

SF-10 Subsonic Filter



SP-7 Stereo Headphones

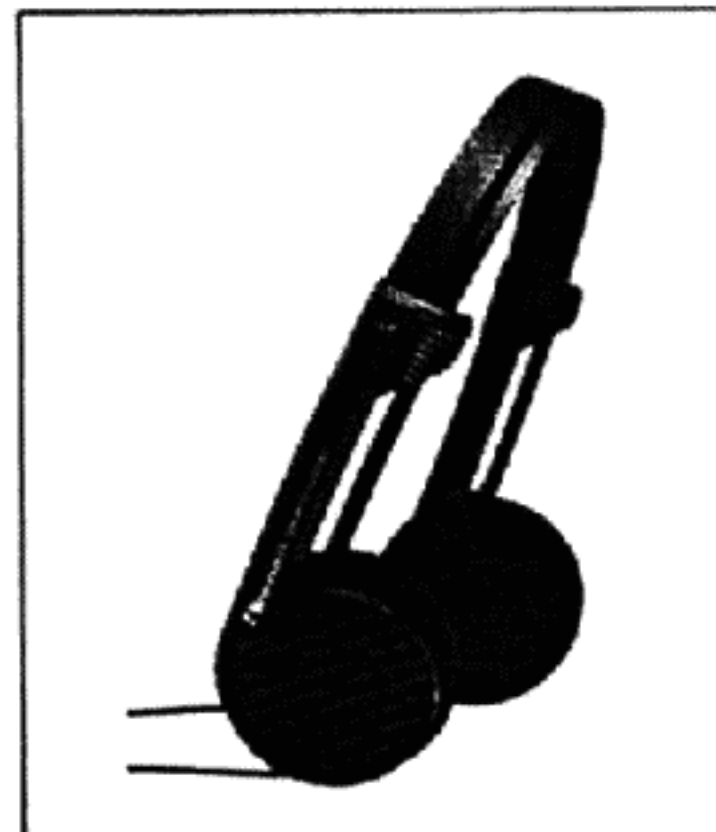

Nakamichi Corporation

Tokyo Office
Shinjuku Daiichi Seimei Bldg.
2-7-1 Nishishinjuku, Shinjuku-ku, Tokyo
Phone (03) 342-4461
Telex : 2324721 (NAKAM J)

Nakamichi U.S.A. Corporation

19701 South Vermont Avenue
Torrance, California 90502
Phone : (213) 538-8150

Nakamichi GmbH

Stephanienstrasse 6, 4000 Düsseldorf 1
Phone : (0211) 359036

Congratulations!

You have chosen an excellent cassette deck. The Nakamichi MR-2 is designed for professional applications in recording studios etc. It delivers outstanding performance in every basic aspect, thanks to original Nakamichi technology

In order to take full advantage of this unit's superior performance, please read this manual in its entirety and retain it for future reference.

Thank you.

Nakamichi Corporation.

Please record the Model Number and Serial Number in the space provided below and retain these numbers.
Model Number and Serial Number are located on the rear panel of the unit.

Model Number: Nakamichi MR-2
Serial Number: _____



CAUTION
TO REDUCE THE RISK OF ELECTRIC SHOCK, DO NOT REMOVE COVER (OR BACK). NO USER-SERVICEABLE PARTS INSIDE. REFER SERVICING TO QUALIFIED SERVICE PERSONNEL.



The lightning flash with arrowhead symbol, within an equilateral triangle, is intended to alert the user of the presence of uninsulated "dangerous voltage" within the product's enclosure, that may be of sufficient magnitude to constitute a risk of electric shock to persons.



The exclamation point within an equilateral triangle is intended to alert the user of the presence of important operating and maintenance (servicing) instructions, in the literature accompanying the appliance.

This equipment generates and uses radio frequency energy and if not installed and used properly, that is, in strict accordance with the manufacturer's instructions, may cause interference to radio and television reception. It has been type tested and found to comply with the limits for a Class B computing device in accordance with the specifications in Subpart J of Part 15 of FCC Rules, which are designed to provide reasonable protection against such interference in a residential installation. However, there is no guarantee that interference will not occur in a particular installation. If this equipment does cause interference to radio or television reception, which can be determined by turning the equipment off and on, the user is encouraged to try to correct the interference by one or more of the following measures:

- reorient the receiving antenna
- relocate this equipment with respect to the receiver
- move this equipment away from the receiver
- plug this equipment into a different outlet so that equipment and receiver are on different branch circuits.

If necessary, the user should consult the dealer or an experienced radio/television technician for additional suggestions. The user may find the following booklet prepared by the Federal Communications Commission helpful:

"How to Identify and Resolve Radio-TV Interference Problems".

This booklet is available from the U.S. Government Printing Office, Washington, DC 20402, Stock No. 004-000-00345-4.

WARNING
TO PREVENT FIRE OR SHOCK HAZARD, DO NOT EXPOSE THIS APPLIANCE TO RAIN OR MOISTURE.

CONTENTS

Safety Instructions.....	3
On Cassette Tapes	3
Controls and Features	4
Connections	5
Precautions Before Operation	6
Operation	7
Systems Calibration.....	8
Maintenance.....	9
Troubleshooting.....	9
Block Diagram.....	10
Specifications.....	11
Optional Accessories	12

Safety Instructions

The following safety instructions have been included in compliance with safety standard regulations. Please read them carefully.

1. **Read Instructions**—All the safety and operating instructions should be read before the appliance is operated.
2. **Retain instructions**—The safety and operating instructions should be retained for future reference.
3. **Heed Warnings**—All warnings on the appliance and in the operating instructions should be adhered to.
4. **Follow Instructions**—All operating and use instructions should be followed.
5. **Water and Moisture**—The appliance should not be used near water—for example, near a bathtub, washbowl, kitchen sink, laundry tub, in a wet basement, or near a swimming pool, etc.
6. **Carts and Stands**—The appliance should be used only with a cart or stand that is recommended by the manufacturer.
7. **Wall or Ceiling Mounting**—The appliance should be mounted to a wall or ceiling only as recommended by the manufacturer.
8. **Ventilation**—The appliance should be situated so that its location or position does not interfere with its proper ventilation. For example, the appliance should not be situated on a bed, sofa, rug or similar surface that may block the ventilation openings; or placed in a built-in installation, such as a bookcase or cabinet that may impede the flow of air through the ventilation openings.
9. **Heat**—The appliance should be situated away from heat sources such as radiators, heat registers, stoves, or other appliances (including amplifiers) which produce heat.
10. **Power Sources**—The appliance should be connected to a power supply only of the type described in the operating instructions or as marked on the appliance.
11. **Grounding or Polarization**—Precautions should be taken so that the grounding or polarization means of an appliance is not defeated.
12. **Power-Cord Protection**—Power-supply cords should be routed so that they are not likely to be walked on or pinched by items placed upon or against them, paying particular attention to cords at plugs, convenience receptacles, and the point where they exit from the appliance.
13. **Cleaning**—The appliance should be cleaned only as recommended by the manufacturer.
14. **Nonuse Periods**—The power cord of the appliance should be unplugged from the outlet when left unused for a long period of time.
15. **Object and Liquid Entry**—Care should be taken so that objects do not fall and liquids are not spilled into the enclosure through openings.
16. **Damage Requiring Service**—The appliance should be serviced by qualified service personnel when:
 - A. The power-supply cord or the plug has been damaged; or,
 - B. Objects have fallen, or liquid has been spilled into the appliance; or,
 - C. The appliance has been exposed to rain; or,
 - D. The appliance does not appear to operate normally or exhibits a marked change in performance; or,
 - E. The appliance has been dropped, or the enclosure damaged.
17. **Servicing**—The user should not attempt to service the appliance beyond that described in the operating instruction. All other servicing should be referred to qualified service personnel.

On Cassette Tapes

Precautions

1. C-120 cassettes (playing time one hour per side) contain extremely thin tape which breaks or snarls easily, is sometimes subject to stretching and also is of low sensitivity. Therefore, C-120 cassettes are not recommended for high-fidelity recording.
2. Do not pull out the tape from the cassette housing.
3. Be careful not to turn the cassette reels with the fingers, causing tape slackening.
4. Store cassette tapes away from heat, high humidity, dust, and magnetic fields such as caused by speakers, TV sets etc.

Cassette Tabs

You can protect valuable recordings from accidental erasure and re-recording by completely removing the appropriate tab on the top edge of the cassette. The tab for each side is located on the top left-hand corner as you face the side. Use a small screwdriver, and push the tab down to break it off. Do not leave the broken tab in the recess. If you wish at a later date to record over a side for which the

tab has been removed, cover the tab opening with a piece of adhesive tape.

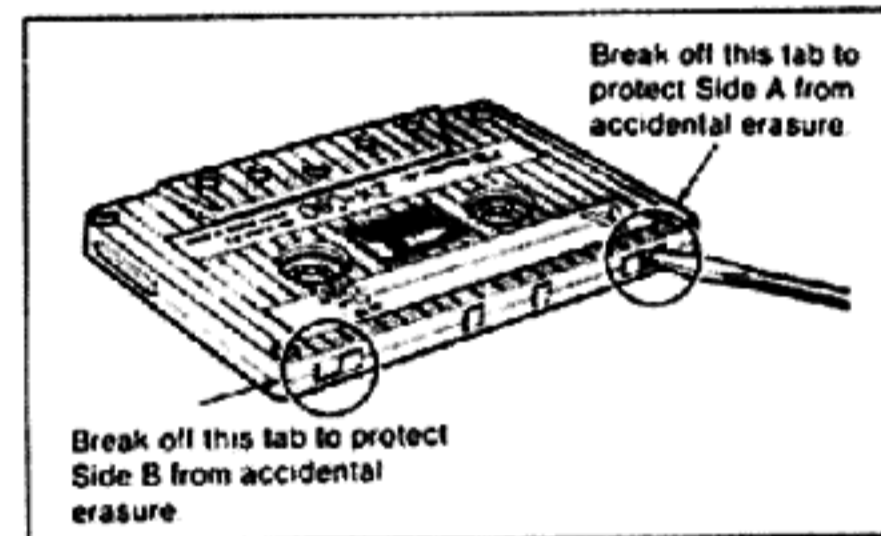

Cassette Insertion and Removal

(1) Insertion of a Cassette

1. When the Eject button is pushed in the stop mode, the cassette holder opens.
 2. Insert the cassette into the holder with the exposed tape facing down and the label of the desired side facing you.
 3. Gently push the cassette holder back into the panel.
- For protection of the tape and tape transport, do not press the Eject button in any mode other than the stop mode.

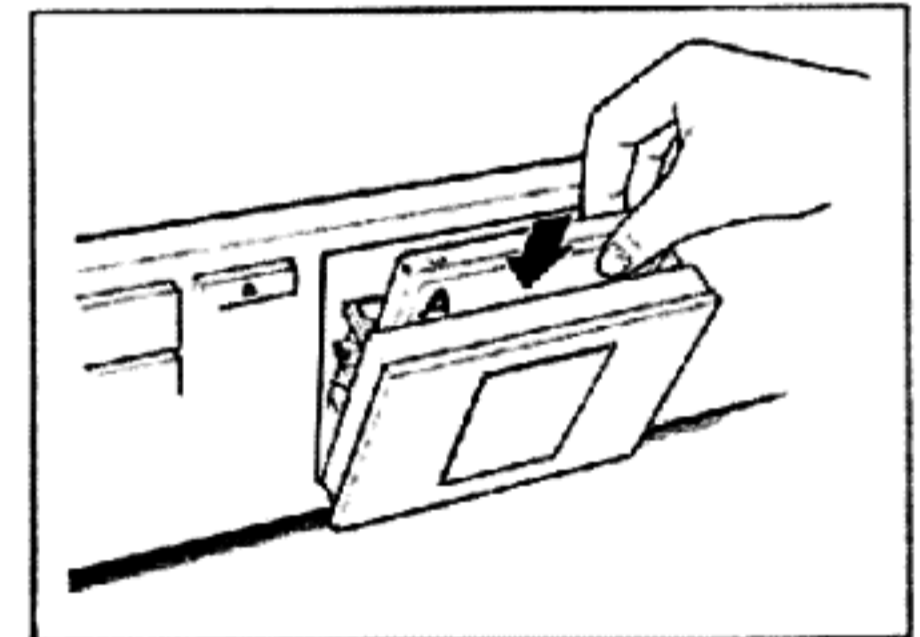

(2) Removal of a Cassette

1. Press the Stop button.
2. When the eject button is pushed, the cassette holder opens.
3. Remove the cassette.