

Nakamichi RX-202

Unidirectional Auto Reverse Cassette Deck

Owner's Manual

Please record the Model Number and Serial Number in the space provided below and retain these numbers.

Model Number and Serial Number are located on the rear panel of the unit.

Model Number: Nakamichi RX-202

Serial Number: _____

CONTENTS

Connections	2
Safety Instructions.....	3
On Cassette Tapes	3
Cassette Insertion and Removal	3
Controls and Features	4
Precautions Before Operation	5
Operation.....	5
The Auto-Reverse System	6
Auto Rec Standby.....	7
Maintenance.....	7
Troubleshooting.....	8
Specifications.....	8



CAUTION
RISK OF ELECTRIC SHOCK. DO NOT OPEN!



CAUTION

TO REDUCE THE RISK OF ELECTRIC SHOCK, DO NOT REMOVE COVER (OR BACK). NO USER-SERVICEABLE PARTS INSIDE. REFER SERVICING TO QUALIFIED SERVICE PERSONNEL.



The lightning flash with arrowhead symbol, within an equilateral triangle, is intended to alert the user of the presence of uninsulated "dangerous voltage" within the product's enclosure: that may be of sufficient magnitude to constitute a risk of electric shock to persons.



The exclamation point within an equilateral triangle is intended to alert the user of the presence of important operating and maintenance (servicing) instructions, in the literature accompanying the appliance.

WARNING

TO PREVENT FIRE OR SHOCK HAZARD, DO NOT EXPOSE THIS APPLIANCE TO RAIN OR MOISTURE.

This equipment generates and uses radio frequency energy and if not installed and used properly, that is, in strict accordance with the manufacturer's instructions, may cause interference to radio and television reception. It has been type tested and found to comply with the limits for a Class B computing device in accordance with the specifications in Subpart J of Part 15 of FCC Rules, which are designed to provide reasonable protection against such interference in a residential installation. However, there is no guarantee that interference will not occur in a particular installation. If this equipment does cause interference to radio or television reception, which can be determined by turning the equipment off and on, the user is encouraged to try to correct the interference by one or more of the following measures:

- reorient the receiving antenna
- relocate this equipment with respect to the receiver
- move this equipment away from the receiver
- plug this equipment into a different outlet so that equipment and receiver are on different branch circuits.

If necessary, the user should consult the dealer or an experienced radio/television technician for additional suggestions. The user may find the following booklet prepared by the Federal Communications Commission helpful: "How to Identify and Resolve Radio-TV Interference Problems".

This booklet is available from the U.S. Government Printing Office, Washington, DC 20402, Stock No. 004-000-00345-4.

Congratulations!

You have chosen a unique and extremely fine cassette deck. The Nakamichi RX-202 possesses the basic performance and overall characteristics of a high-grade cassette deck. Furthermore, by employing a unidirectional auto-reverse mechanism, it provides an ingenious and complete solution to the inherent drawbacks of conventional auto-reverse systems.

This auto-reverse cassette deck for recording and playback is based on a totally new concept. Please take the time to read this manual in its entirety to fully acquaint yourself with all its features.

Thank you.

Nakamichi Corporation.

Connections

After consulting the instructions for your amplifier or receiver, use the shielded cables with RCA plugs (provided with the deck) to make connections as shown in the chart. Take care not to mix up left and right channels. While making connections, the power to the deck and to the amplifier should be switched off.

Headphones

Standard stereo headphones with an impedance of 8-150 ohms may be connected to the headphone jack.

Microphone Connections

The RX-202 possesses only line facilities. When microphones are to be used for recording, a separate microphone mixer with a line output must be connected to this deck's line input terminals. Nakamichi offers the optional MX-100 Microphone Mixer, which provides three inputs for left, right and center blend (L + R) microphones. To power the MX-100, the separate PS-100 Power Supply is required.

Removal of Transport Fastening Jig

Before connecting the cassette deck, remove the transport fastening jig on the bottom of the cassette deck. Be sure to retain the fastening jig and screw, as these will be needed again for renewed transport or shipping of the cassette deck.

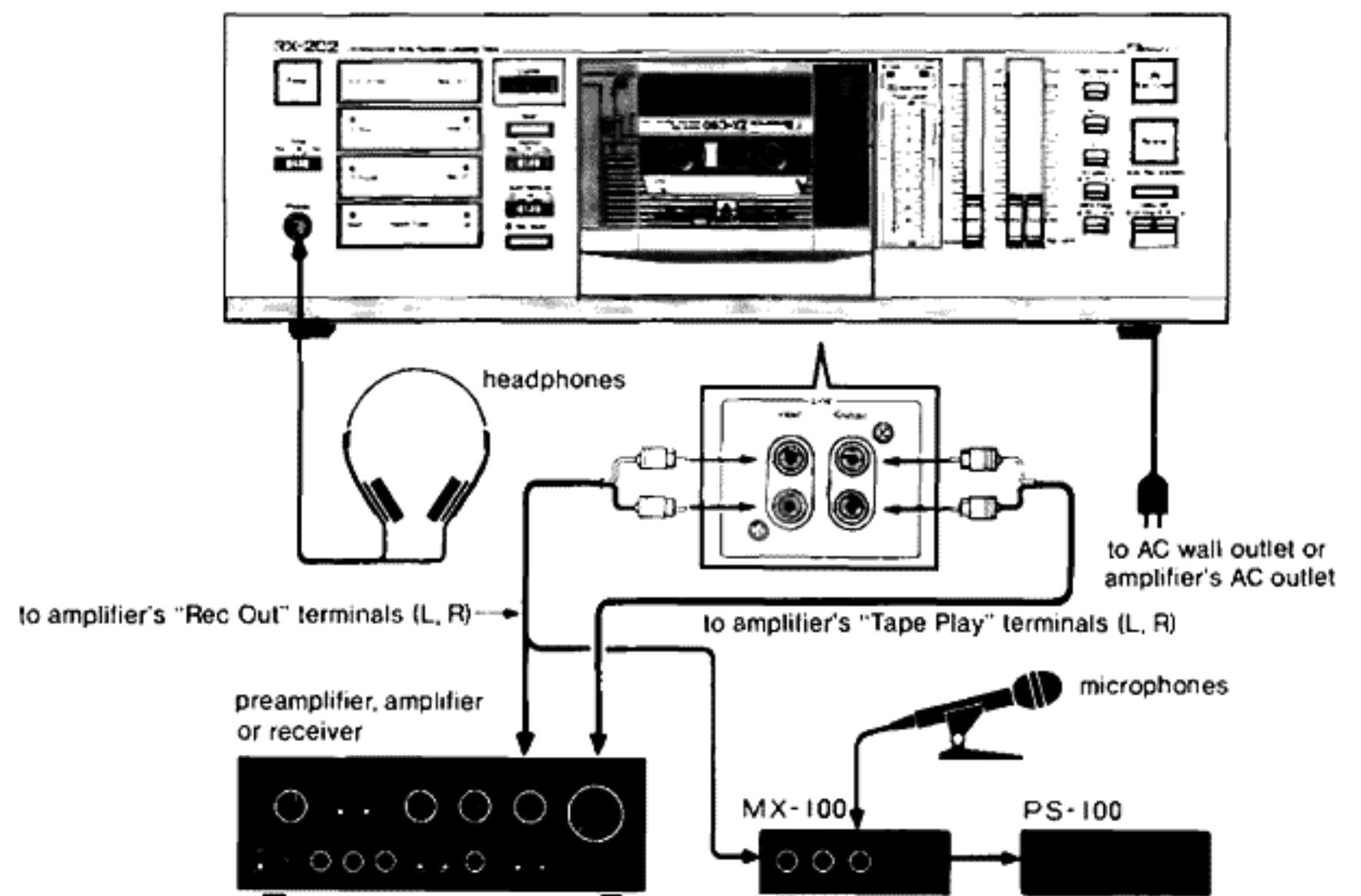
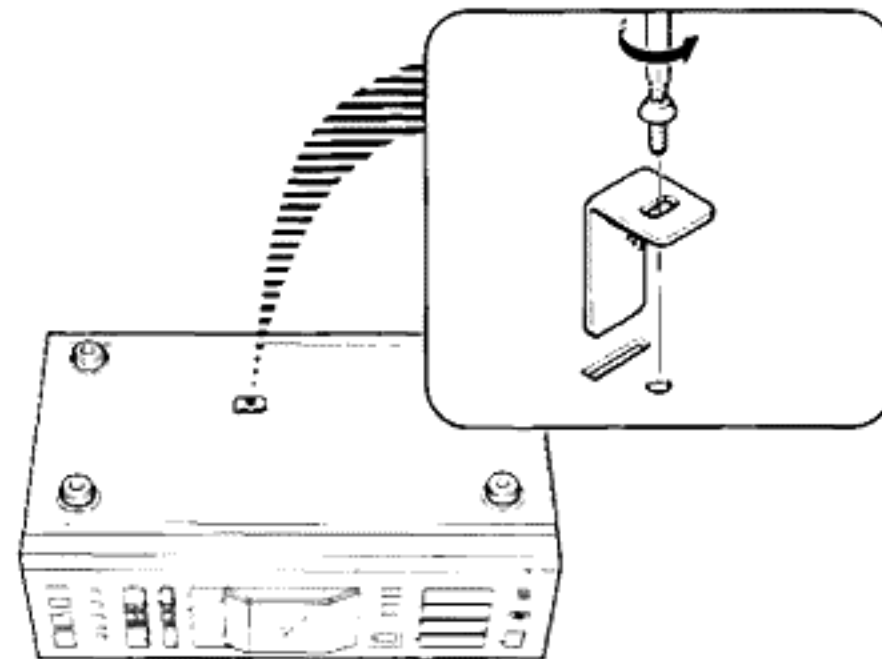

Tape Selector and Equalizer Switch Setting Chart

This cassette deck was calibrated at the factory with Nakamichi reference tapes. To obtain optimum results and fully realize this deck's potential, the use of Nakamichi tapes is recommended. When using other tapes, you should choose tapes from the list, whenever possible.

Tape Selector	Eq (μ sec)	Brand/Designation	
Normal Position TYPE EX(I)	120 μ SEC	Nakamichi Fuji Maxell TDK	EX, EX II FR I UD, UD-XL I, XL I-S AD, AD-X
Chrome (Cobalt) Position TYPE SX(II)	70 μ SEC	Nakamichi Fuji Maxell TDK	SX, SX II FR II UD-XL II, XL II-S SA, SA-X
Metal Position TYPE ZX(IV)	70 μ SEC	Nakamichi Fuji Maxell TDK	ZX FR Metal MX MA, MA-R

Controls and Features

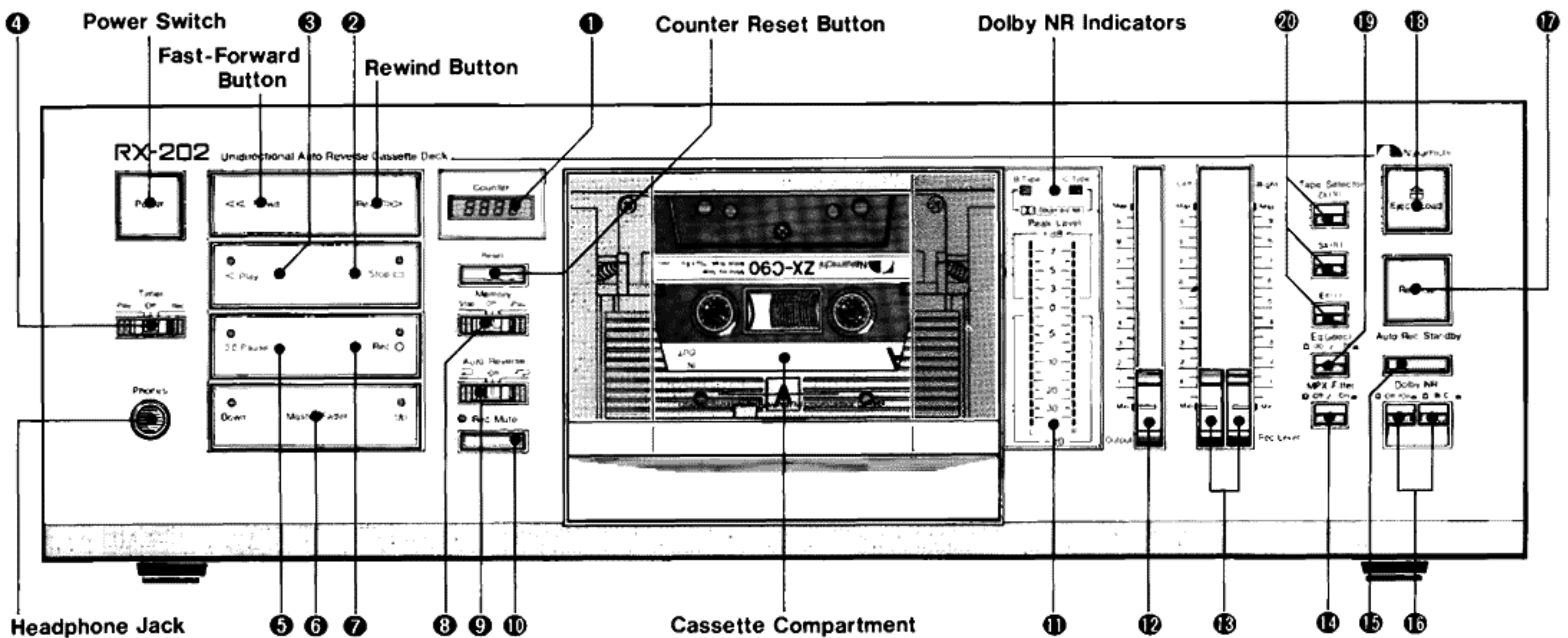

(1) Tape Counter

Starting from "0000", tape travel is indicated in the range from "9999" to "-999". Counter indication is reset to "0000" when the Reset button is pressed, and also when the power is switched on, the tape is reversed, and the Auto Rec Standby operation is completed.

(2) Stop Button

When the section marked with \square is pressed, tape motion comes to a full stop and the indicator lights up.

(3) Play Button

To start playback of a tape or start recording from the record-standby mode, press the section marked with \triangleleft . During operation, the indicator lights up.

(4) Timer Switch

This switch is used for timer-activated recording or playback. In ordinary operation, it must be set to "Off". (→p. 6)

(5) Pause Button

When the section marked with \square is pressed during recording or playback, the tape motion is interrupted and the indicator lights up. To restart the tape, press the Play button.

(6) Master Fader Button

This button is used to perform fade-in or fade-out during recording. (→p. 5)

(7) Record Button

Simply by pressing the section marked with \circ , the record-standby mode is entered, and the indicator lights up.

(8) Memory Switch

This switch is used for the Memory Stop and Memory Play functions. (→p. 5)

(9) Reverse Mode Switch

This switch serves to select the auto-reverse mode for recording and playback. (→p. 6)

(10) Rec Mute Button

When this button is pressed during recording, the recording signal is cut off for as long as the button is kept depressed. (→p. 5)

(11) Peak Level Meters

Provide exact indication of peak levels in the range of -30 dB to +7 dB.

(12) Output Level Control

Serves to adjust the line output and the headphone output level.

(13) Input Level Controls

Serve to adjust the recording level for left and right channels.

(14) MPX Filter Switch

Used to suppress the 19-kHz multiplex carrier signal, which could interfere with proper Dolby NR operation when recording from FM stereo broadcasts. When recording from other sources or during playback, this switch should be set to "Off".

Safety Instructions

The following safety instructions have been included in compliance with safety standard regulations. Please read them carefully.

1. **Read Instructions** — All the safety and operating instructions should be read before the appliance is operated.
2. **Retain instructions** — The safety and operating instructions should be retained for future reference.
3. **Heed Warnings** — All warnings on the appliance and in the operating instructions should be adhered.
4. **Follow Instructions** — All operating and use instructions should be followed.
5. **Water and Moisture** — The appliance should not be used near water — for example, near a bathtub, washbowl, kitchen sink, laundry tub, in a wet basement, or near a swimming pool, etc.
6. **Carts and Stands** — The appliance should be used only with a cart or stand that is recommended by the manufacturer.
7. **Wall or Ceiling Mounting** — The appliance should be mounted to a wall or ceiling only as recommended by the manufacturer.
8. **Ventilation** — The appliance should be situated so that its location or position does not interfere with its proper ventilation. For example, the appliance should not be situated on a bed, sofa, rug or similar surface that may block the ventilation openings; or placed in a built-in installation, such as a bookcase or cabinet that may impede the flow of air through the ventilation openings.
9. **Heat** — The appliance should be situated away from heat sources such as radiators, heat registers, stoves, or other appliances (including amplifiers) which produce heat.
10. **Power Sources** — The appliance should be connected to a power supply only of the type described in the operating instructions or as marked on the appliance.
11. **Grounding or Polarization** — Precautions should be taken so that the grounding or polarization means of an appliance is not defeated.
12. **Power-Cord Protection** — Power-supply cords should be routed so that they are not likely to be walked on or pinched by items placed upon or against them, paying particular attention to cords at plugs, convenience receptacles, and the point where they exit from the appliance.
13. **Cleaning** — The appliance should be cleaned only as recommended by the manufacturer.
14. **Nonuse Periods** — The power cord of the appliance should be unplugged from the outlet when left unused for a long period of time.
15. **Object and Liquid Entry** — Care should be taken so that objects do not fall and liquids are not spilled into the enclosure through openings.
16. **Damage Requiring Service** — The appliance should be serviced by qualified service personnel when:
 - A. The power-supply cord or the plug has been damaged; or,
 - B. Objects have fallen, or liquid has been spilled into the appliance; or,
 - C. The appliance has been exposed to rain; or,
 - D. The appliance does not appear to operate normally or exhibits a marked change in performance; or,
 - E. The appliance has been dropped, or the enclosure damaged.
17. **Servicing** — The user should not attempt to service the appliance beyond that described in the operating instruction. All other servicing should be referred to qualified service personnel.

On Cassette Tapes

Precautions

1. C-120 cassettes (playing time one hour per side) contain extremely thin tape which breaks or snarls easily, is sometimes subject to stretching and also is of low sensitivity. Therefore, C-120 cassettes are not recommended for high-fidelity recording.
2. Do not pull out the tape from the cassette housing.
3. Be careful not to turn the cassette reels with the fingers, causing tape slackening.
4. Store cassette tapes away from heat, high humidity, dust, and magnetic fields such as caused by speakers, TV sets etc.

Cassette Tabs

You can protect valuable recordings from accidental erasure and re-recording by completely removing the appropriate tab on the top edge of the cassette. The tab for each side is located on the top left-hand corner as you face the side. Use a small screwdriver, and push the tab down to break it off. Do not leave the broken tab in the recess. If you wish at a later date to record

over a side for which the tab has been removed, cover the tab opening with a piece of adhesive tape.

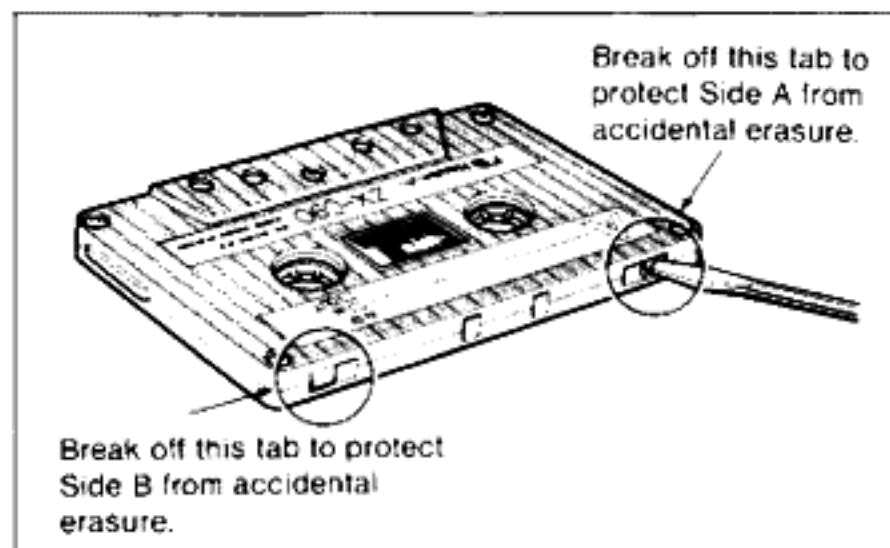

Cassette Insertion and Removal

(1) Insertion of a Cassette

1. By pressing the Eject/Load button, the cassette compartment slides out.
2. Place the cassette in the cassette holder with side A facing outward and the exposed tape facing up.
3. By pressing the Eject/Load button again, the cassette compartment is drawn in and the cassette is set in place. Also, if the Play, Fast-Forward or Rewind button is pressed in the eject condition, the cassette will be set at side A and

the respective mode will be entered without the need to press the Eject/Load button.

- To listen only to side B, press the Reverse button. The cassette will be set in reverse, with side B facing outward.

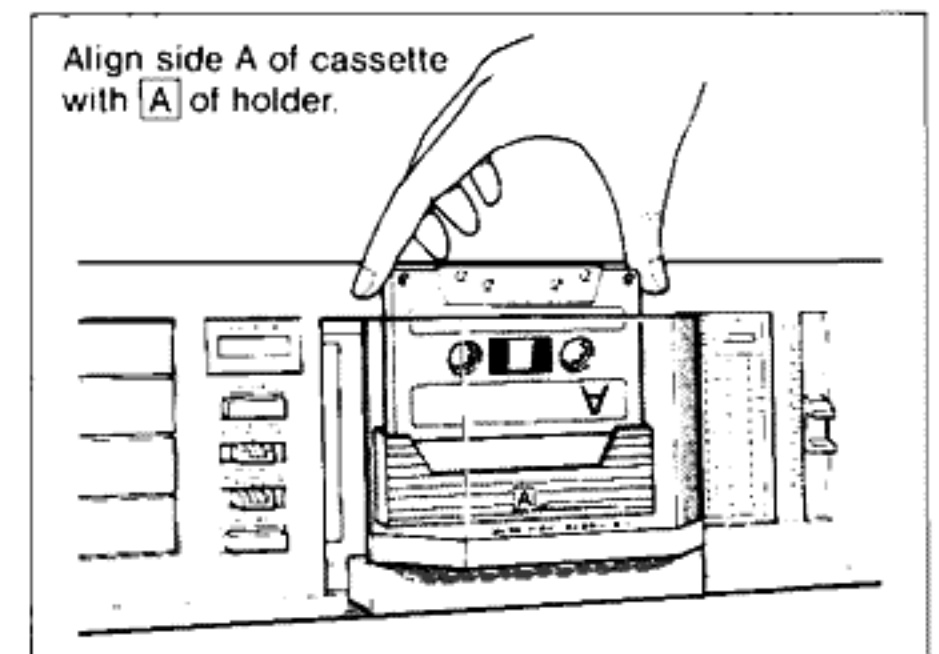

(2) Removal of a Cassette

1. By pressing the Eject/Load button in any operation mode, not only stop but also recording, playback, fast-forward, etc., the tape motion stops and the cassette compartment slides out. At this time, side A always faces outward (eject condition).
2. Remove the cassette.

(15) Auto Rec Standby Button

When this button is pressed, the tape runs from the start for 6 seconds in the Rec Mute condition, and then the deck goes into the record-standby mode. (—p. 7)

(16) Dolby NR Switches

To activate the Dolby NR system, the left switch must be set to "On". The right switch serves to select either the B-type or the C-type system. The respective Dolby NR indicator lights up.

(17) Reverse Button

Serves to reverse the cassette.

(18) Eject/Load Button

This button is used for ejection and insertion of the cassette.

(19) Equalizer Switch

Serves to set the correct equalization in recording and playback for the tape in use. (—p. 4)

(20) Tape Selector Switches

In recording, the correct switch must be pressed for the tape in use. (—p. 4)

■ Dolby NR System

This cassette deck provides a choice between the Dolby B-type and the Dolby C-type noise reduction systems. The Dolby B-type NR provides approximately 10 dB of noise reduction in the high frequencies. The Dolby C-type NR is a further refined system, which achieves a S/N ratio improvement of about 20 dB in the range from 2 kHz to 8 kHz, where noise is most readily audible.

For playback of a tape which was recorded with the B-type NR, set the Dolby NR switch to "B". For playback of a tape recorded with Dolby C-type NR, set the switch to "C".

Precautions Before Operation

- (1) This deck incorporates a muting circuit which is active for about 4 seconds after the power was switched on, until all circuits have become stable. During the muting interval, tape transport operation is not possible. However, the Eject/Load button and the Reverse button can be operated.
- (2) If the power is switched on while the Timer switch is set to "Rec" or "Play", recording or playback will start automatically. In order to prevent accidental erasure of a tape, be sure to set the Timer switch to "Off" when the timer function is not desired.

- (3) With this deck you can go from any mode into any other (for example from playback to rewind, from rewind to fast-forward, etc.) without having to press the Stop button.
- (4) If the reverse operation cannot be performed due to an obstacle in front of the cassette deck, the cassette compartment will return to its initial position. If the cassette compartment is in the extended position and is pushed inward by external force, loading starts automatically. Be careful not to exert excessive pressure on the cassette compartment cover.

(5) Voltage Selector

AC voltage is factory-set for the country in which you purchased your RX-202. The voltage selector permits re-setting of mains voltage in case the deck is to be used in a different country.

Note:

Safety regulations in certain countries prohibit inclusion of a voltage selector. This feature, therefore, may be absent from your deck.

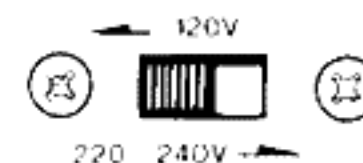

Operation

- Insert a cassette, referring to "Cassette Insertion and Removal" on page 3.

Playback

By pressing the Play button in the eject condition, the tape is automatically set at side A and playback starts.

- (1) Set the Equalizer switch to the required position for the tape in use. (—p. 4)
- (2) Set the Dolby NR switches to the same position as used for recording.
- (3) Press the Play button.
- (4) Adjust the Output Level control to obtain the desired listening level.
 - During playback, this deck's Peak Level meters display the level recorded on the tape. Readings are not affected by turning the Output Level control.

■ Memory Switch

If the Memory switch is set to "Stop", the tape will stop automatically when the Counter indication "0000" is reached in fast-forward or rewind. If the switch is set to "Play", playback will start automatically from this point.

Recording

- (1) Set the Tape Selector switches and the Equalizer switch to the required positions for the tape in use. (—p. 4)
- (2) Select the desired position of the Dolby NR switches. For recording from FM broadcasts, set the MPX Filter switch to "On".
- (3) Simply press the Rec button to set the deck to the record-standby (Rec/Pause) mode.
- (4) Set the recording level with the Rec Level controls, while watching the indication of the Peak Level meters.
- (5) Press the Play button to start recording. To temporarily stop the tape while remaining in the record-standby mode, press the Pause button. To resume recording, press the Play button once more.

Note:

- Be careful not to press the Eject/Load button by mistake during recording, as this will result in the recording being interrupted and the tape being ejected.

■ Rec Mute

When the Rec Mute button is pressed during recording, a blank portion is recorded on the tape for as long as the button is kept depressed. As the line output and headphone output are not muted during this operation, the input signal can be continuously monitored.

■ Master Fader

This feature permits smooth and easy fades (gradual level increase or decrease) during recording. By pressing the "Down" section of the Master Fader button, fade-out is performed automatically. By pressing the "Up" section (after having decreased the level by pressing "Down"), fade-in is performed automatically. You can choose between two fading speeds: By keeping "Up" or "Down" depressed, fading is completed in about 2 seconds. By depressing the button once and then releasing it, fading is completed in about 4 seconds. The respective fading mode is indicated by the brightness of the indicators.

Note:

- The operation of the fader control can be changed from "Up" to "Down" or from "Down" to "Up", but it cannot be stopped midway.
- The Master Fader is operative only in the record and record-standby modes. When these modes are released, the setting automatically becomes "Up". The Master Fader is also reset to "Up" at the start of side B in reverse recording, when the recording of side A was terminated with a fade-out.

Record Level Setting

For good recordings, it is essential to maintain a high signal-to-noise ratio. If the record level is set too low, tape hiss will impair the playback sound quality. If it is set too high, the tape will be driven into distortion. Refer to the chart below to set recording levels.

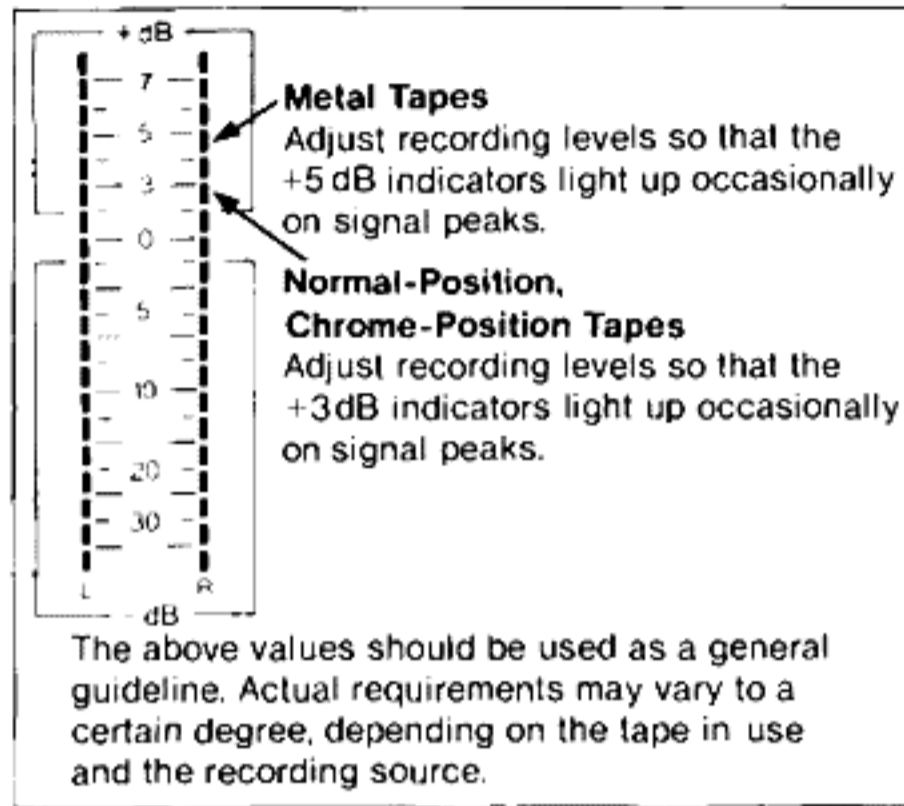

Timer Recording or Playback

- (1) Establish connections as shown in the chart, and switch on the power to all components.
- (2) For timer-activated recording, set the recording level to suit the expected signal. For timer-activated playback, set the Output control to the desired level.
- (3) For timer-activated recording, set this deck's Timer switch to "Rec". For timer-activated playback, set the switch to "Play".
- (4) Set the timer to the desired operation time.
- (5) At the pre-selected time, the timer will supply power to the components, and recording or playback will start automatically.

Notes:

- Be sure to set this deck's Timer switch to "Off" when timer recording or playback is not to be carried out.
- If the record-protection tabs of the inserted cassette are removed, timer-activated recording is not possible and the deck will go into the stop mode.

- If the power to the deck is cut off while the cassette is being rotated, the cassette compartment will remain in the eject condition when the power is switched on again. If consecutive recording is to be carried out with a timer, set the timer so that power will not be switched off while the cassette is being rotated.

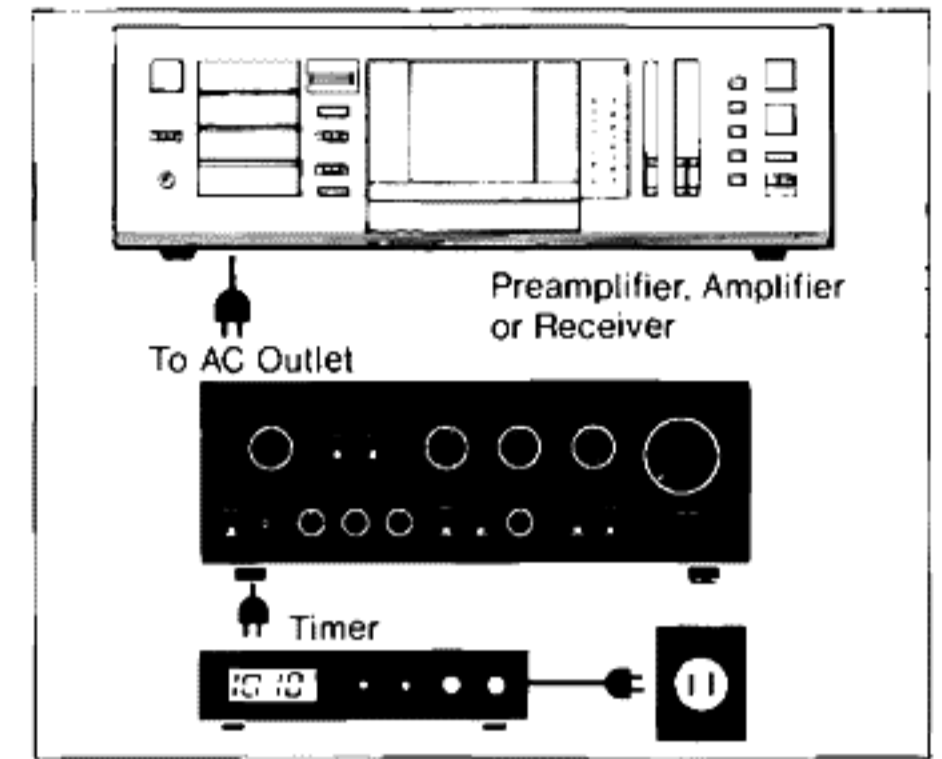

The Auto-Reverse System

[Auto-Reverse Operation Using the Reverse Mode Switch]

When the Reverse Mode switch ('Auto Reverse') is set to "Off", the auto-reverse system is inactive and the RX-202 operates as an ordinary cassette deck with automatic stop at the tape end after playback or recording of one side.

(1) Auto-Reverse Playback

When the Reverse Mode switch is set to \rightarrow , side B is played back automatically after side A is terminated. At the end of side B, the tape stops. If the switch is set to \leftrightarrow , sides A and B are played back in endless succession. When the tape end is reached in fast-forward or playback, the cassette is automatically reversed, then the tape is fast-forwarded for the length of the leader tape section, and playback starts at the beginning of the magnetic tape section of the other side.

- When a blank section (recorded level below -30 dB) of more than 40 seconds is detected, the tape is automatically fast-forwarded to the end of the side for reverse operation and playback of the other side. (Due to this feature, the deck will immediately go into the fast-forward mode when the Reverse Mode switch is set from "Off" to \rightarrow or \leftrightarrow during a blank section of more than 40 seconds.)
- If a low-level recorded section of less than -30 dB continues for more than 40 seconds, the reverse operation of this deck

will be triggered even during playback of a musical selection.

(2) Auto-Reverse Recording

With the Reverse Mode switch set to \rightarrow or \leftrightarrow and the deck in the recording mode, auto-reverse recording will be carried out, in the order of side A \rightarrow side B. At the end of side B, the tape stops automatically. Even with the Reverse Mode switch set to \leftrightarrow , auto-reverse recording in the order of side B \rightarrow side A is not possible.

- If the record-protection tabs of side B are removed, tape run of side B will be in the playback mode.

[Operation of the Reverse Button]

When the Reverse button is pressed in the stop mode, the cassette is reversed and loaded again. When the button is pressed in the record, playback or pause mode, the cassette is reversed and the deck again goes into the record, playback or pause mode.

- For protection of the tape, the Reverse button is inoperative during fast-forward and rewind.
- If the Reverse button is pressed again during the reverse operation, the cassette is reversed once more, but regardless of the previous mode, the tape will be in the stop mode. Therefore, if the Reverse button was pressed by mistake, pressing it immediately once more cause it to operate as a stop button.

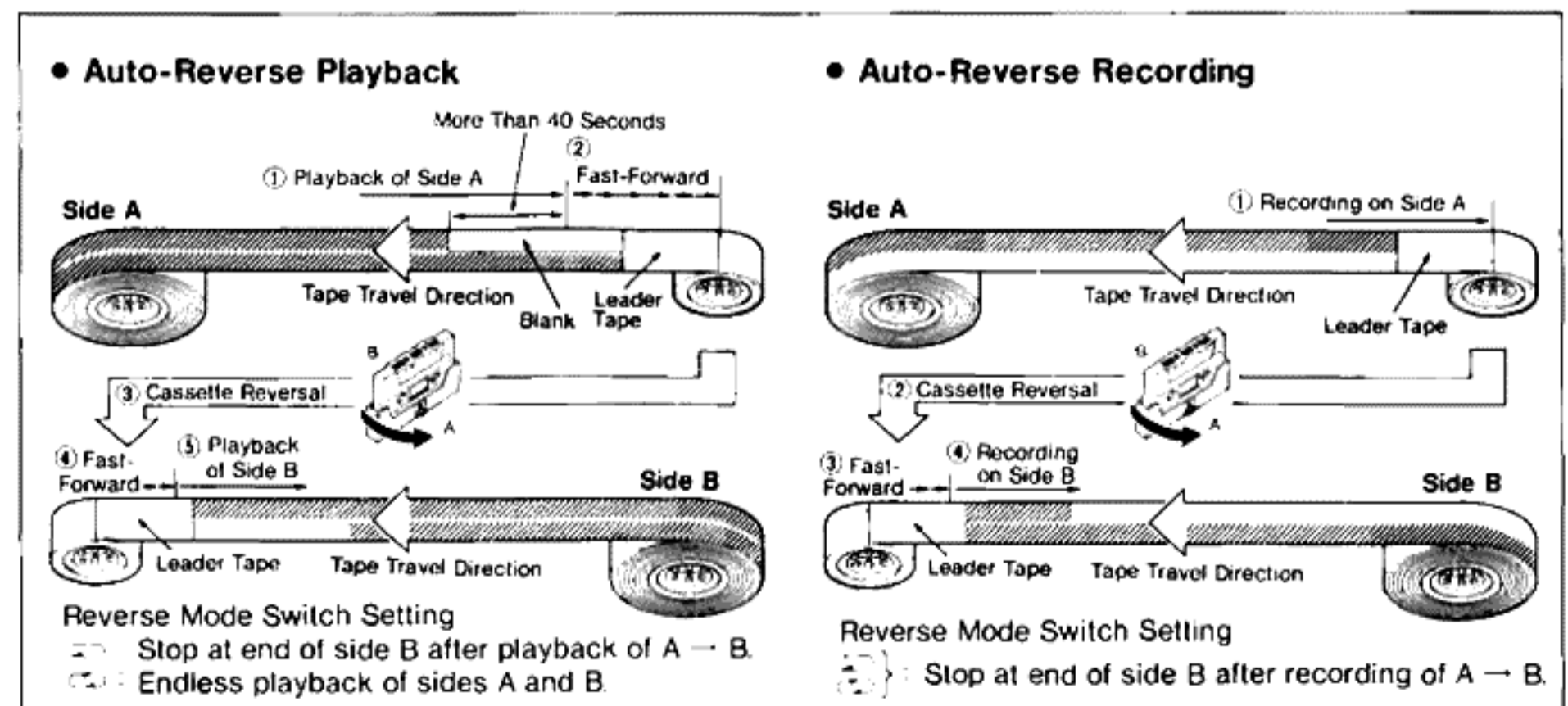

Auto Rec Standby

The Auto Rec Standby button has two different functions, depending on whether it is pressed once or twice.

(1) Press the button **once** if you are at some point on a tape and you want to start recording again from the beginning of the same side (for example to recommence a recording which has not turned out as planned, etc.). The deck automatically performs the following operating sequence: **rewind to the beginning of the side** ⇨ **fast-forward for the portion of the leader tape** ⇨ **6 seconds tape run in Rec Mute condition** ⇨ **record-standby mode**.

(During this operation, the Record indicator flashes.)

This feature is also handy with a tape which is already rewound to the beginning. Pressing the button will result in the following sequence: **fast-forward for the portion of the leader tape** ⇨ **6 seconds tape run in Rec Mute condition** ⇨ **record-standby mode**.

(2) Press the button **twice** in short succession (within 0.5 seconds) if you are at some point of side A, but want to start recording

(1) Button Pressed Once

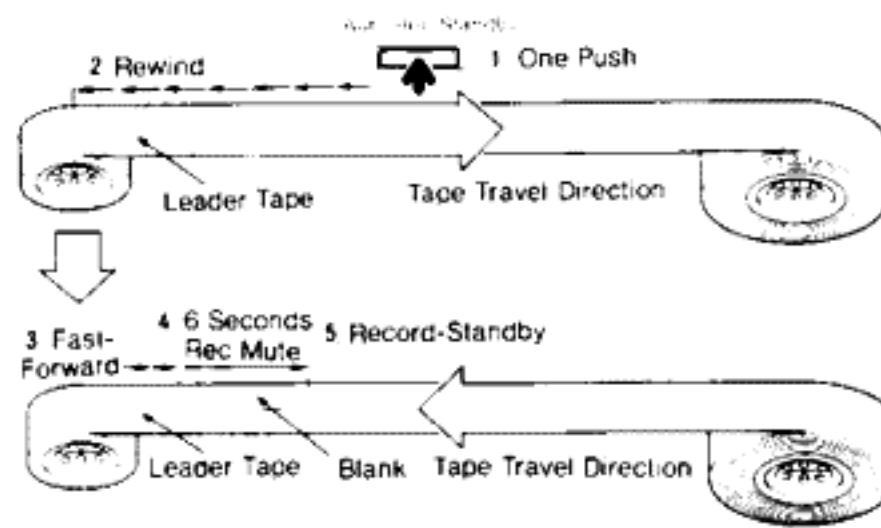

With tapes which are already rewound to the beginning, this sequence starts from 3.

(2) Button Pressed Twice

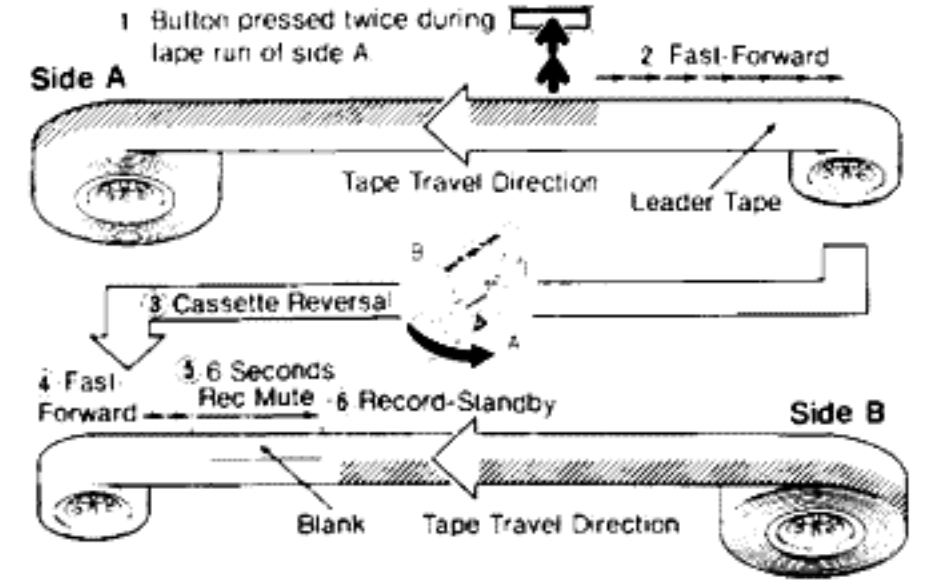

from side B. The deck automatically performs the following operating sequence: **fast-forward to the end of side A** ⇨ **cassette reversal** ⇨ **fast-forward for the portion of the leader tape** ⇨ **6 seconds tape run in Rec Mute condition** ⇨ **record-standby mode**. (During this operation, the Record indicator flashes.)

- This operating sequence can be performed also with the Reverse Mode switch set to "Off".
- If you are at some point of side B, the operation described in (2) is not

possible, and the operating sequence of (1) only will result.

- If the Auto Rec Standby button was pressed by mistake, the operation can be cancelled by pressing the Stop button.
- During fast-forward or rewind, the Auto Rec Standby button is inactive.
- If the record-protection tabs of a cassette are removed, the tape will stop after being forwarded for the leader tape section.

Maintenance

Cleaning

It is very important to regularly clean the head surfaces and transport section, etc. Contamination caused by tiny particles shedded from the tape onto these parts can become the cause of drop-outs and severely degrade high-frequency response and wow-and-flutter characteristics. Perform cleaning as follows.

- (1) Remove the cassette compartment cover in the eject condition, and then press the Eject/Load button to slide the cassette compartment in.
- (2) Press the Play button and clean the revolving pressure roller by holding a cotton-tipped stick lightly against the roller on the side turning away from the capstan. Be careful that the cotton tip does not get caught between the roller and the capstan.
- (3) Press the Pause button to release the pressure roller from the capstan. Now clean the capstan and the surfaces of the heads and tape guides with a cotton-tipped stick. Be careful not to apply too much force. Take special care not to damage the tape guides.

- After cleaning, make sure that no cotton strands are left on any of the cleaned parts.
- In case of severe contamination, moisten the cotton tip with a small amount of commercially available

Be careful not to exert excessive pressure on the cassette compartment cover.

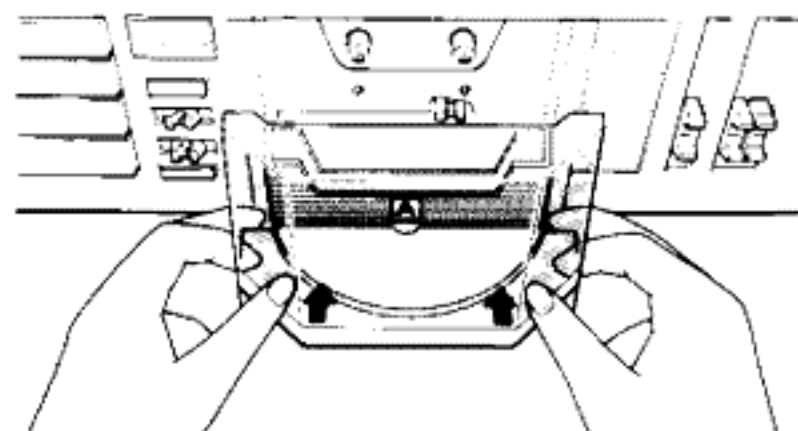

- **Removal of Cassette Compartment Cover**
While steadying the base section of the cassette compartment with the middle finger, grip the cover between thumb and index finger and push it in the direction indicated by the arrow. The snap lock is released and the cover can be removed.

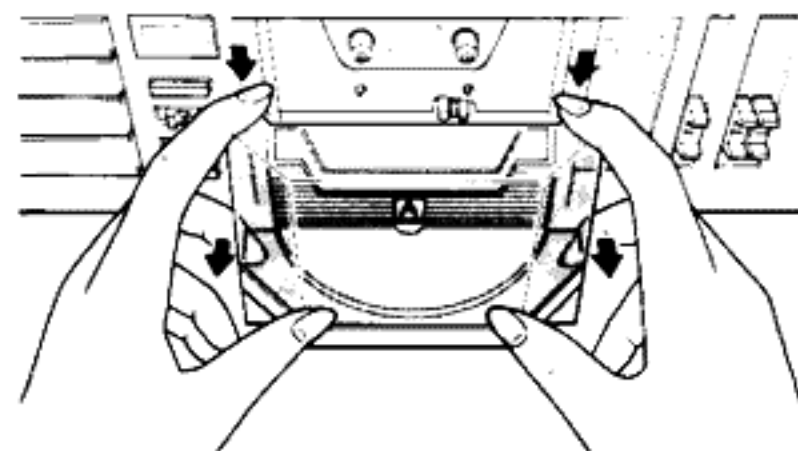

- **Reattachment of Cassette Compartment Cover**
Support the cassette compartment with your thumb. Press the cover down with the index finger while pulling it towards you with the middle finger to engage the snap lock.

cleaning fluid especially designed for this purpose.
After cleaning with a cleaning fluid, wait

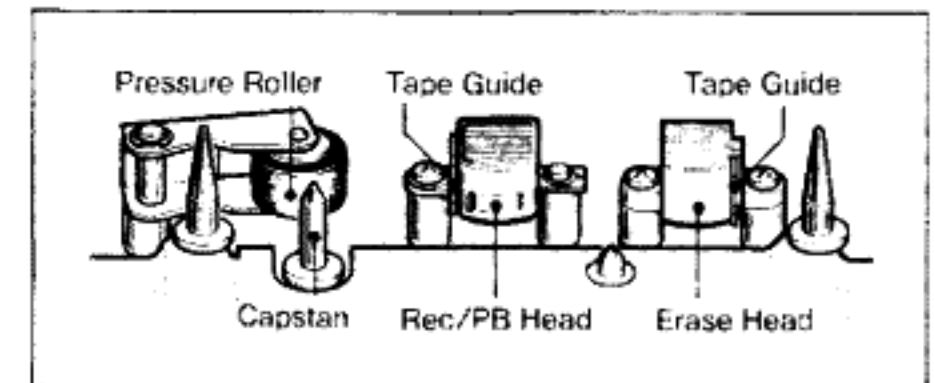

until any residue has completely dried off before playing a tape.

Demagnetizing

After a longer period of use, there can be a build-up of residual magnetism in the heads and capstan. Such residual magnetism can induce noise and partially erase the high frequencies of a tape being played. To prevent this, you should demagnetize these parts about once every 50 hours of use with the Nakamichi DM-10 Demagnetizer (optional) or any other properly designed demagnetizer. For details, refer to the instruction manual of the demagnetizer.

Lubrication

All important moving parts this cassette deck are fitted with long-life, oil-less bearings. Periodic lubrication is therefore not necessary.

Cleaning the Faceplate

Clean the faceplate only by wiping it with a soft, dry cloth. Never use alcohol, solvents, ammonia or abrasive cleaning agents.

Troubleshooting

Condition	Probable Cause	Remedy
Record mode cannot be entered.	1. Cassette tabs have been removed.	1. Place adhesive tape over tab opening or use new cassette.
Excessive playback hiss.	2. Head is magnetized.	2. Demagnetize head.
Uneven sound levels, drop-outs, excessive wow/flutter.	3. Heads and/or capstan and pressure roller dirty. 4. Faulty cassette.	3. Clean these parts. 4. Replace cassette.
Incomplete erasure.	5. Erase head dirty.	5. Clean head and pressure roller.
Distorted record/playback sound.	6. Program material itself is distorted. 7. Recording levels are too high. 8. Head dirty. 9. Wrong setting of tape selector switches.	6. Check program material. 7. Wide dynamic range permits some short-term overload, but excessive recording levels will cause distortion. Adjust recording levels. 8. Clean head. 9. Select correct setting for the tape in use.
Record mode is entered, but cannot record.	10. Input disconnected. 11. Head dirty.	10. Check connections. 11. Clean head.
Cannot playback.	12. Output disconnected. 13. Head dirty.	12. Check connections. 13. Clean head.
Dull high frequencies.	14. Head dirty. 15. Tape selector switches and/or equalizer switch not set correctly.	14. Clean head. 15. Select correct positions for tape in use.
Hum heard during recording or playback.	16. Strong induction fields near deck. 17. Signal cable or connector grounding faulty.	16. Keep deck away from amplifier, transformers, fluorescent lamps, etc. 17. Replace signal cables.

Specifications

Track Configuration.....	4 tracks/2-channel stereo (auto-reverse recording and playback)	Separation	Better than 36 dB (1 kHz, 0 dB)
Heads.....	2 (erase head x 1, record/playback head x 1)	Crosstalk	Better than 60 dB (1 kHz, 0 dB)
Motors (Tape Transport).....	DC servo motor (capstan drive) x 1 DC motor (reel drive) x 1	Bias Frequency	105 kHz
Power Source.....	100, 120, 120/220-240, 220 or 240V AC; 50/60Hz (According to country of sale)	Fast-Winding Time.....	Approx. 85 seconds (with C-60 cassette)
Power Consumption.....	30 W max.	Input (Line)	50 mV, 30 k Ω
Tape Speed.....	1-7/8 ips. (4.8 cm/sec.) \pm 0.5%	Output (Line).....	0.5V (400 Hz, 0 dB, output level control at max.) 2.2 k Ω
Wow-and-Flutter.....	Less than \pm 0.11% WTD Peak Less than 0.06% WTD RMS	(Headphones).....	2.2 mW (400 Hz, 0 dB, output level control at max.) 8 Ω load
Frequency Response	20 Hz - 20,000 Hz (recording level - 20 dB)	Dimensions	450 (W) \times 136(H) \times 255(D) millimeters 17-3/4(W) \times 5-3/8(H) \times 10(D) inches
Signal-to-Noise Ratio.....	Dolby C-Type NR on < 70 μ s, ZX tape > Better than 68 dB (400 Hz, 3% THD, IHF A-WTD RMS) Dolby B-Type NR on < 70 μ s, ZX tape > Better than 62 dB (400 Hz, 3% THD, IHF A-WTD RMS)	Approximate Weight	9 kg 19 lb. 13 oz
Total Harmonic Distortion.....	Less than 1.0% (400 Hz, 0 dB, ZX, EX II tape) Less than 1.2% (400 Hz, 0 dB, SX tape)		
Eraseure	Better than 60 dB (100 Hz, + 10 dB)		

- Specifications and appearance design are subject to change for further improvement without notice.
- Noise Reduction System manufactured under license from Dolby Laboratories Licensing Corporation
- The word "DOLBY" and the Double-D-Symbol are trademarks of Dolby Laboratories Licensing Corporation.

Nakamichi Corporation
Tokyo Office
Shinjuku Daiichi Seimei Bldg.
2-7-1 Nishishinjuku, Shinjuku-ku, Tokyo
Phone (03) 342-4461
Telex : 2324721 (NAKAM J)

Nakamichi U.S.A. Corporation
19701 South Vermont Avenue
Torrance, California 90502
Phone : (213) 538-8150

Nakamichi GmbH
Stephanienstrasse 6, 4000 Düsseldorf 1
Phone : (0211) 359036