





Nakamichi ZX-7
Discrete Head Cassette Deck
Owner's Manual



CAUTION

TO REDUCE THE RISK OF ELECTRIC SHOCK, DO NOT REMOVE COVER (OR BACK). NO USER-SERVICEABLE PARTS INSIDE. REFER SERVICING TO QUALIFIED SERVICE PERSONNEL.

 The lightning flash with arrowhead symbol, within an equilateral triangle, is intended to alert the user of the presence of uninsulated "dangerous voltage" within the product's enclosure; that may be of sufficient magnitude to constitute a risk of electric shock to persons.

 The exclamation point within an equilateral triangle is intended to alert the user of the presence of important operating and maintenance (servicing) instructions, in the literature accompanying the appliance.

WARNING

TO PREVENT FIRE OR SHOCK HAZARD, DO NOT EXPOSE THIS APPLIANCE TO RAIN OR MOISTURE.

Please record the Model Number and Serial Number in the space provided below and retain these numbers.

Model Number and Serial Number are located on the rear panel of the unit.

Model Number: Nakamichi ZX-7

Serial Number: _____

CONTENTS

Safety Instructions	1
On Cassette Tapes	2
Precautions	2
Controls and Features	3
Connections	6
Special Features	8
Playback	11
Before Recording	12
Recording	17
Tips on Setting Record Levels	18
Dolby Noise Reduction System	19
Maintenance	20
Troubleshooting	21
Specifications	22

Congratulations!

You have chosen an extremely fine cassette deck. The Nakamichi ZX-7 possesses facilities for manually adjusting azimuth, record sensitivity and bias to perfectly match every tape. This gives the active-minded tape enthusiast full control over every important aspect.

The versatile adjustment mechanism was designed for easy, efficient use. Latest technologies are employed in every part of the deck, and a microprocessor for tape transport control ensures smooth and error-free operation.

Please take the time to read this manual in its entirety to fully acquaint yourself with the various features of this cassette deck.

Thank you.

Nakamichi Corporation.

Safety Instructions

The following safety instructions have been included in compliance with safety standard regulations. Please read them carefully.

1. **Read Instructions** — All the safety and operating instructions should be read before the appliance is operated.
2. **Retain instructions** — The safety and operating instructions should be retained for future reference.
3. **Heed Warnings** — All warnings on the appliance and in the operating instructions should be adhered.
4. **Follow Instructions** — All operating and use instructions should be followed.
5. **Water and Moisture** — The appliance should not be used near water — for example, near a bathtub, washbowl, kitchen sink, laundry tub, in a wet basement, or near a swimming pool, etc.
6. **Carts and Stands** — The appliance should be used only with a cart or stand that is recommended by the manufacturer.
7. **Wall or Ceiling Mounting** — The appliance should be mounted to a wall or ceiling only as recommended by the manufacturer.
8. **Ventilation** — The appliance should be situated so that its location or position does not interfere with its proper ventilation. For example, the appliance should not be situated on a bed, sofa, rug or similar surface that may block the ventilation openings; or placed in a built-in installation, such as a bookcase or cabinet that may impede the flow of air through the ventilation openings.
9. **Heat** — The appliance should be situated away from heat sources such as radiators, heat registers, stoves, or other appliances (including amplifiers) which produce heat.
10. **Power Sources** — The appliance should be connected to a power supply only of the type described in the operating instructions or as marked on the appliance.
11. **Grounding or Polarization** — Precautions should be taken so that the grounding or polarization means of an appliance is not defeated.
12. **Power-Cord Protection** — Power-supply cords should be routed so that they are not likely to be walked on or pinched by items placed upon or against them, paying particular attention to cords at plugs, convenience receptacles, and the point where they exit from the appliance.
13. **Cleaning** — The appliance should be cleaned only as recommended by the manufacturer.
14. **Nonuse Periods** — The power cord of the appliance should be unplugged from the outlet when left unused for a long period of time.
15. **Object and Liquid Entry** — Care should be taken so that objects do not fall and liquids are not spilled into the enclosure through openings.
16. **Damage Requiring Service** — The appliance should be serviced by qualified service personnel when:
 - A. The power-supply cord or the plug has been damaged; or,
 - B. Objects have fallen, or liquid has been spilled into the appliance; or,
 - C. The appliance has been exposed to rain; or,
 - D. The appliance does not appear to operate normally or exhibits a marked change in performance; or,
 - E. The appliance has been dropped, or the enclosure damaged.
17. **Servicing** — The user should not attempt to service the appliance beyond that described in the operating instruction. All other servicing should be referred to qualified service personnel.

Precautions

1. C-120 cassettes (playing time one hour per side) contain extremely thin tape which breaks or snarls easily, is sometimes subject to stretching and also is of low sensitivity. Therefore, C-120 cassettes are not recommended for high-fidelity recording.
2. Do not pull out the tape from the cassette housing.
3. Be careful not to turn the cassette tape reels with the fingers, causing tape slackening.
4. Store cassette tapes away from heat, high humidity, dust and magnetic fields such as caused by speakers, TV sets etc.

Cassette Tabs

You can protect valuable recordings from accidental erasure and re-recording by completely removing the appropriate tab on the top edge of the cassette. The tab for each side is located on the top left-hand corner as you face the side. Use a small screwdriver, and push the tab down to break it off. Do not leave the broken tab in the recess. If you wish at a later date to record over a side for which the tab has been removed, cover the tab opening with a piece of adhesive tape.

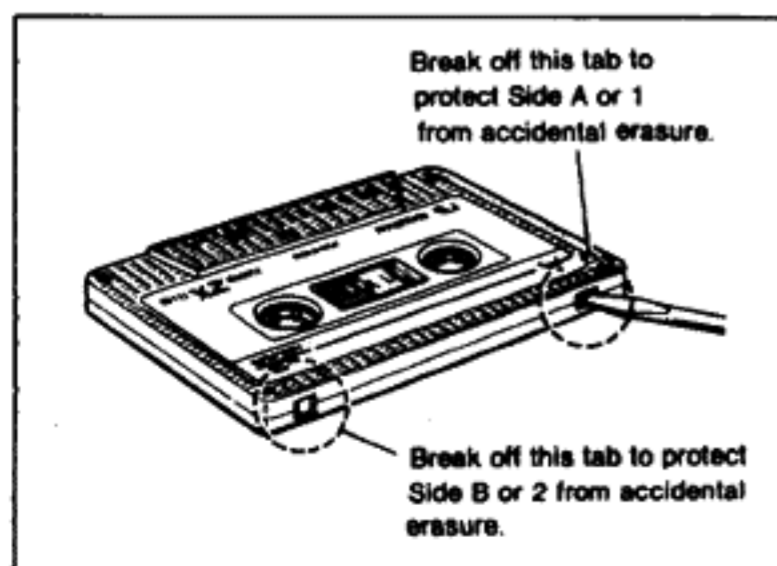

Insertion and Removal

(1) Insertion of a Cassette

1. Push the eject button to open the cassette holder.
2. Load the cassette into the holder from the top. Make sure that the exposed tape is facing down and the label of the desired side is facing you.
3. Close the cassette holder gently by pushing the holder back into the panel.

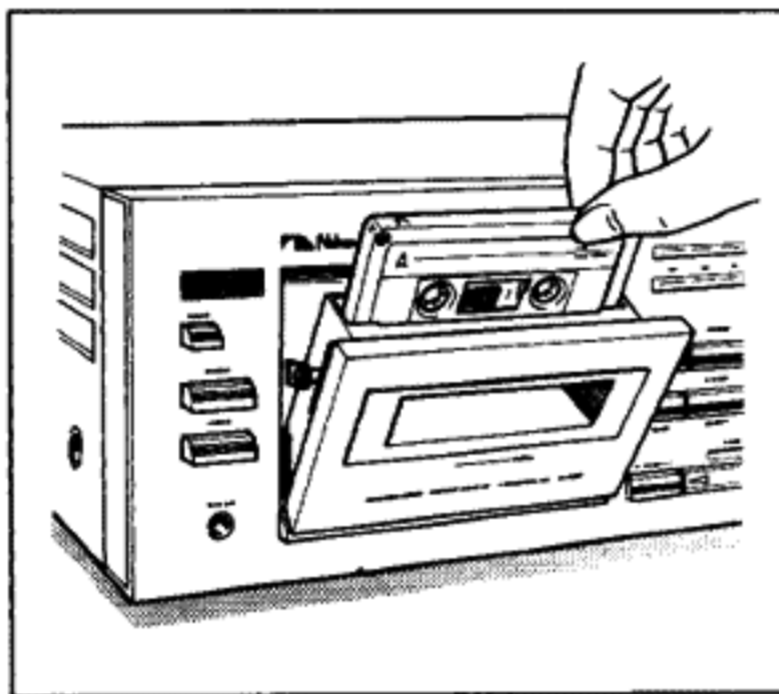

(2) Removal of a Cassette

1. Push the stop button.
2. Push the eject button to open the cassette holder.
3. Remove the cassette.

1. Calibration Control Covers

The sensitivity and bias controls of this deck are adjusted at the factory to fit the recommended tapes. To preserve these settings, the controls are fitted with protective covers for shipment. Before using the deck, these covers should be removed.

2. Make sure that the tape start memory/timer switch is set to "Off" or "Memory" when the self-start feature is not desired.
3. This deck incorporates a special circuit designed to take up any loose tape inside the cassette. When a tape is inserted, the take-up spindle (right-hand spindle) will make a few rotations. The take-up spindle will also rotate and the tape counter will advance by a few digits if: a cassette containing loose tape is inserted, or the cassette holder is closed without a cassette, or the power to the deck is switched on. This behavior is normal and not a fault with the deck.
4. This deck incorporates a muting circuit to prevent the generation of spurious noise when switching on the power. While the muting circuit is active, the light above the stop button (11) flashes and the tape transport buttons ("Play", "F.Fwd", "Rew" and "Pause") are inoperative. When the timer function for recording or playback is used, the respective mode is entered after the muting interval (when the flashing of the stop button light has stopped).

Controls and Features

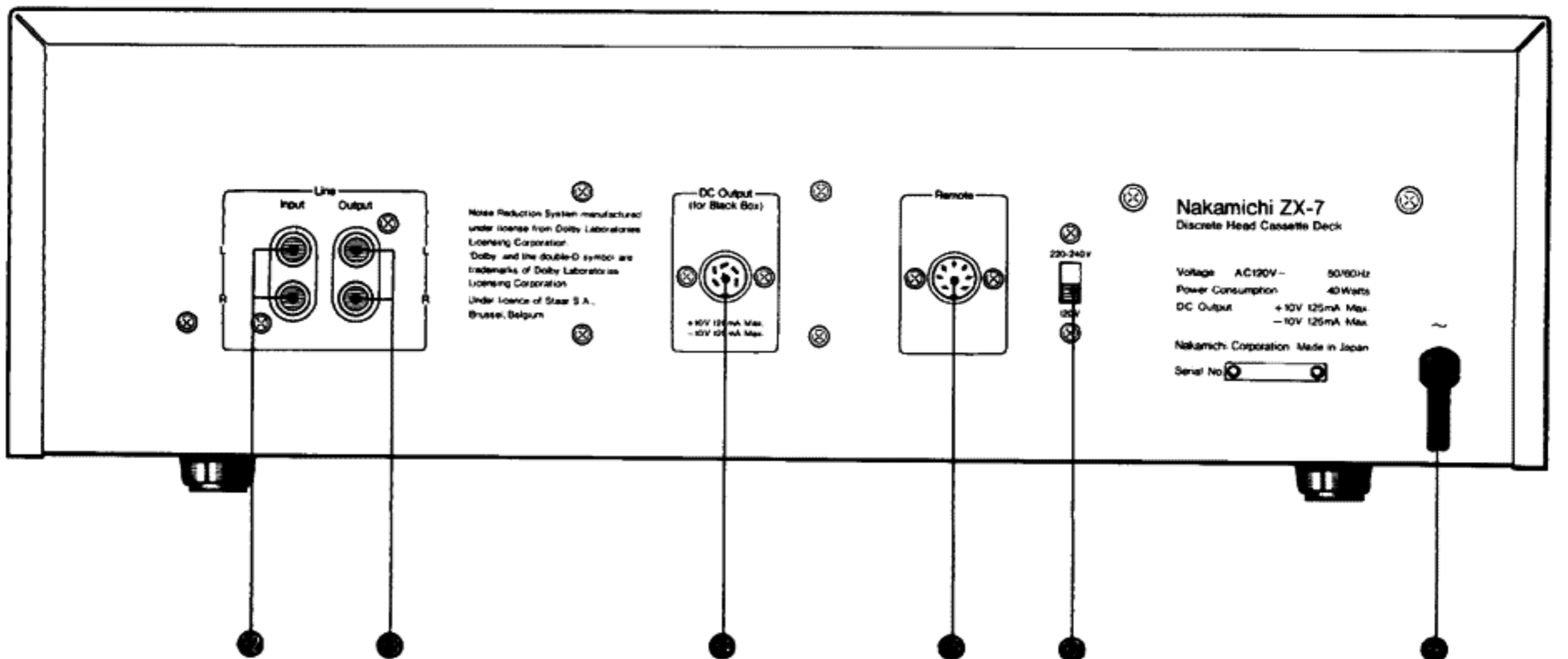
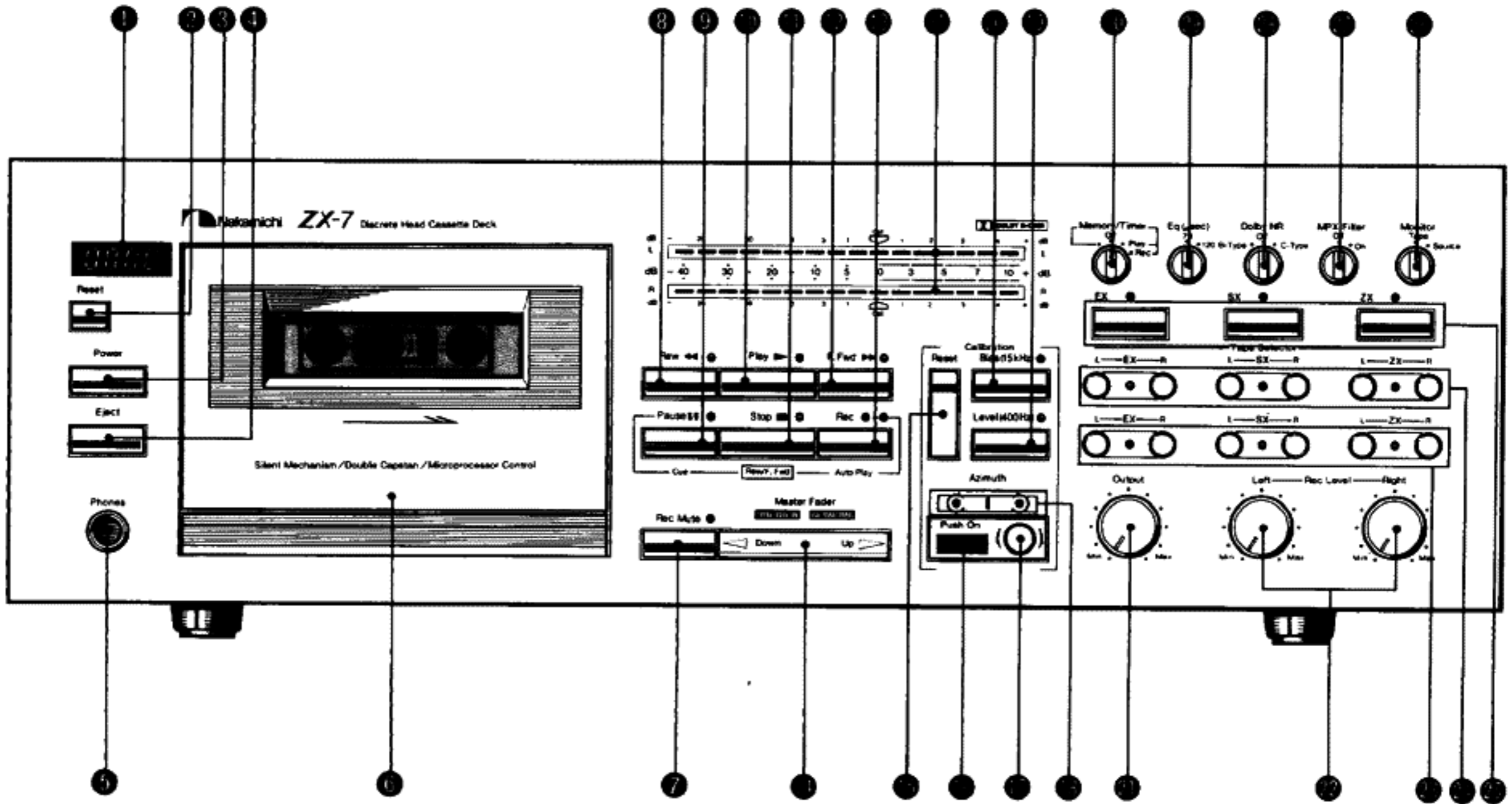

(1) Tape Counter

Digital LED indicators count from "0000" to "9999" in the record, playback and fast-forward modes ("plus count"), and to "-999" in the rewind mode ("minus count").

(2) Counter Reset Button

Pressing this button returns the tape counter to "0000".

(3) Power Switch

Pressing this button activates the deck. Pressing it once more switches the power off. When the power is switched on, the cassette holder illumination is lit and the tape counter (1) is reset.

(4) Eject Button

Depressing this button opens the cassette holder for insertion and removal of a cassette.

(5) Headphone Jack

Accepts standard stereophone plug. (→p. 6)

(6) Cassette Holder

See-thru cover provides unobstructed view of the cassette. The cover can be easily removed for routine cleaning of heads, capstans and pinchrollers etc. (→p. 20)

(7) Rec Mute Button

By depressing this button during recording, the input signal can be temporarily cut off. While the rec mute function is operating, the indicator on the top right of the button lights up. (→p. 8)

(8) Rewind Button

For rapid tape-winding in the reverse direction. While the tape is winding, the indicator on the top right of the button lights up.

(9) Pause Button

Used for noise-free, short-term interruption of the tape transport in recording or playback. Also activates the cueing feature (→p. 9). During operation, the indicator on the top right of the button lights up.

(10) Play Button

Starts forward tape motion for recording or playback. During operation, the indicator on the top right of the button lights up.

(11) Stop Button

Brings all tape motion to a full stop from any mode. During operation, the indicator on the top right of the button lights up.

(12) Fast-Forward Button

For rapid tape-winding in the forward direction. During operation, the indicator on the top right of the button lights up.

(13) Record Button

Used for recording and also for the auto play feature (→ p. 8). During recording, the indicator on the top right of the button lights up.

(14) Master Fader Control

By means of this control, fade-in or fade-out during recording can be performed easily at the touch of a button. There is also a choice between two fading speeds. The indicators above the master fader control display the function being performed. (→p. 8)

(15) Calibration Reset Button

Used to release the calibration mode after adjustment of azimuth, record sensitivity and bias has been completed. (→p. 13)

(16) Azimuth Alignment Start Button

Used to start the alignment procedure for record head azimuth. When this button is depressed in the record-standby mode, the deck automatically goes into the record mode. Azimuth adjustment can now be easily performed by turning the azimuth alignment knob (17) while watching the azimuth indicators (18). (→p. 13)

(17) Azimuth Alignment Knob

Used to adjust the record head azimuth.

(18) Azimuth Indicators

The adjustment of record head azimuth is performed while watching these indicators.

(19) Level Calibration Start Button

Used to adjust the record sensitivity for a given tape. When this button is depressed in the record-standby mode, the deck automatically goes into the record mode and calibration can now be performed easily by turning the sensitivity controls (23) while watching the peak level meters (31). (→p. 14)

(20) Bias Calibration Start Button

Used to adjust the bias current for a given tape. When this button is depressed in the record-standby mode, the deck automatically goes into the record mode and calibration can now be performed easily by turning the bias controls (24) while watching the peak level meters (31). (→p. 14)

(21) Output Level Control

Controls the output level as well as the headphones listening level for both channels simultaneously.

(22) Input Level Controls (L, R)

Used to adjust the input (record) level to the deck and the left/right channel balance. Fade-in or fade-out can be performed with the master fader control (14). (→p. 17)

(23) Sensitivity Controls

Used to adjust the record sensitivity (record/playback level) for each tape selector position and for left and right channels separately. (→p. 12)

(24) Bias Controls

Used to adjust the bias current for each tape selector position and for left and right channels separately. (→p. 14)

(25) Tape Selector Buttons

Used to select the EX, SX or ZX position. For Nakamichi EX and EX II tapes or other low-noise/high-output ferric oxide tapes, push the "EX" button. For Nakamichi SX tape or other chrome-equivalent tapes, push the "SX" button. For Nakamichi ZX or other metal tapes, push the "ZX" button. The respective indicator lights up. (→p. 12)

(26) Monitor Switch

For playback of a tape, for off-the-tape monitoring during recording and for any calibration, set this switch to "Tape". For record level setting etc., set this switch to "Source".

(27) MPX Filter Switch

When this switch is set to "On", a filter cuts off the 19-kHz multiplex carrier signal used in FM stereo broadcasts. Remains of this carrier might otherwise interfere with correct operation of the Dolby system. The switch should be set to "Off" when recording anything else than FM broadcasts.

(28) Dolby NR Switch

Used to select either Dolby B-Type noise reduction for a 10-dB improvement in high-frequency S/N ratio, or the Dolby C-Type noise reduction system for a 20-dB improvement. (→p. 19)

(29) Eq Switch

Used to select either 70 or 120 microsecond equalization. (→p. 12)

(30) Tape Start Memory/Timer Switch

The tape start memory operates when the switch is set to "Memory". In rewind or fast-forward, the tape is automatically stopped when the tape counter reaches the "0000" indication. This deck also incorporates an auto play function which is activated by the record button and automatically puts the deck into the playback mode at "0000". (→p. 8) The "Timer—Play" and "Timer—Rec" positions of the switch can be used for pre-programmed playback or unattended recording in conjunction with an external audio timer. (→p. 10)

(31) Peak Level Meters

Provide exact indication of peak levels in the range of -40 dB to +10 dB. (→p. 18)

(32) Input Jacks (Left and Right Channel)**(33) Output Jacks (Left and Right Channel)****(34) DC Output Jack (For BlackBox Series Only)**

Provides a DC voltage to power optional components from Nakamichi's BlackBox series (such as the MX-100 Microphone Mixer etc.).

The maximum capacity of this outlet is 125 mA. Components connected to this jack must not exceed 125 mA in total current consumption!

(35) Remote Control Jack

Accepts the respective plug of the optional remote control unit RM-200 for operation of the tape transport.

(36) Power Cord**(37) Voltage Selector**

AC Voltage is factory set for the country in which you purchased your ZX-7. The voltage selector permits re-setting of mains voltage in case the deck is to be used in a different country.

Note:

Safety regulations in certain countries prohibit inclusion of a voltage selector. This feature, therefore, may be absent from your deck.

Connection of Amplifier and Remote Control

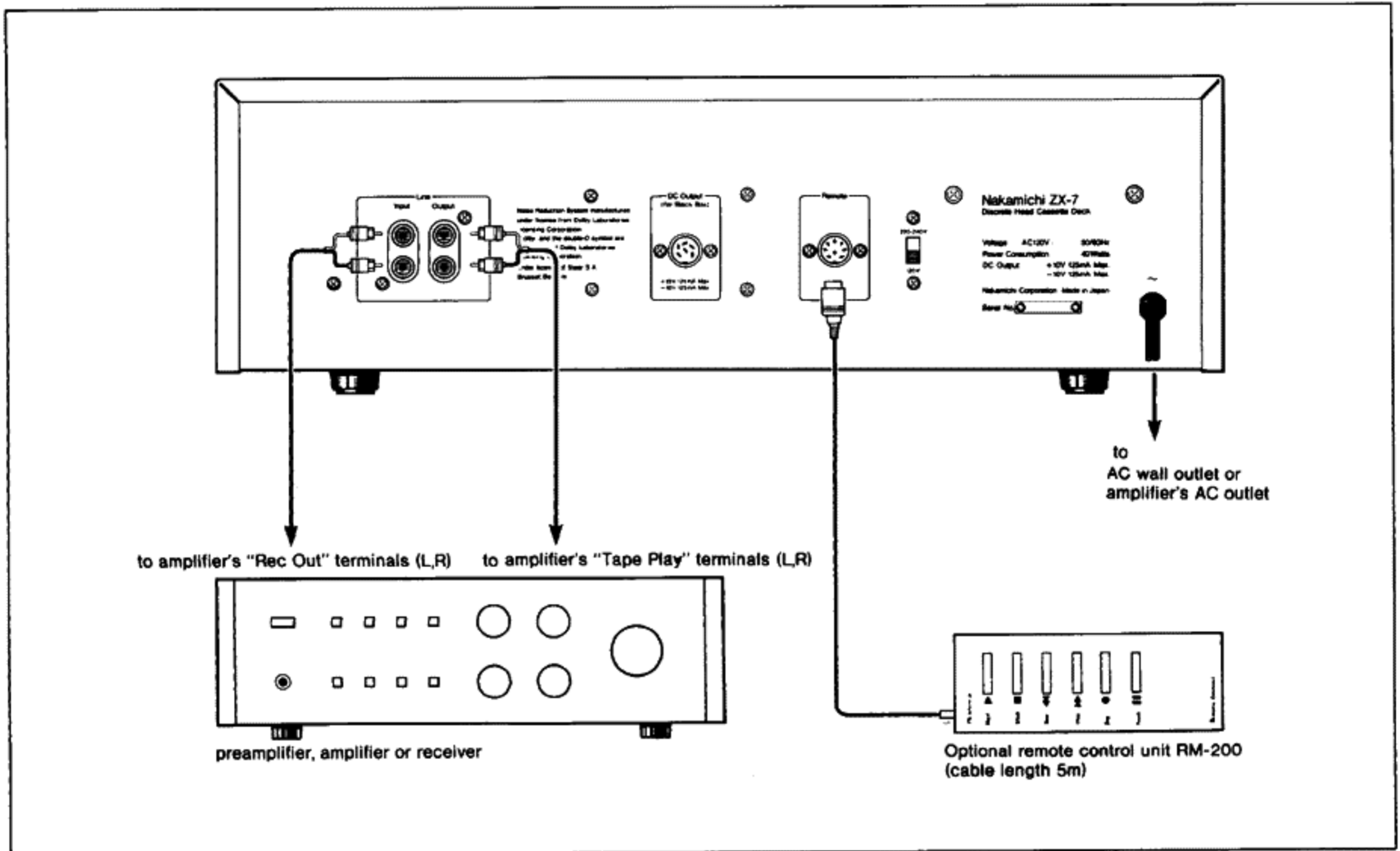

After checking the instructions for your amplifier or receiver, use the shielded cables with RCA plugs (provided with the deck) to securely connect this deck's input jacks (32) with the "Rec Out" terminals on the amplifier and this deck's output jacks (33) to the "Tape Play" terminals on the amplifier. Be careful not to mix up left and right channels. While making connections, the power to the deck and to the amplifier should be switched off.

Remote Control

The optional remote control unit RM-200 permits operation of the deck's tape transport functions (excluding the Rec Mute function) from any convenient location.

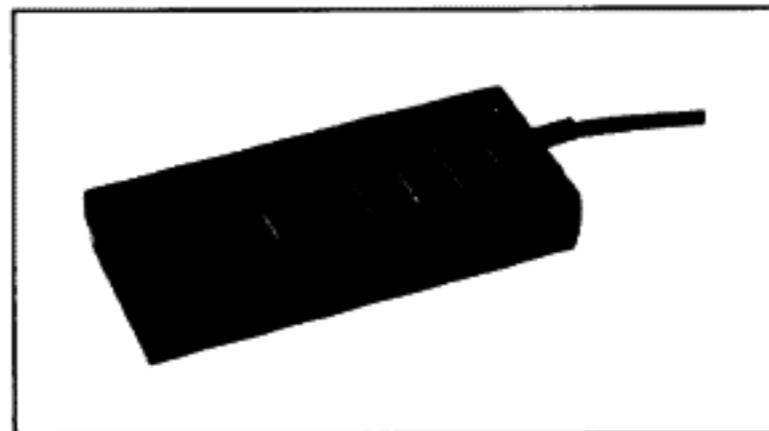

Headphones

Standard stereo headphones may be connected to the jack on the front panel of the deck. Low-impedance headphones of 8 or 16 ohms are recommended.

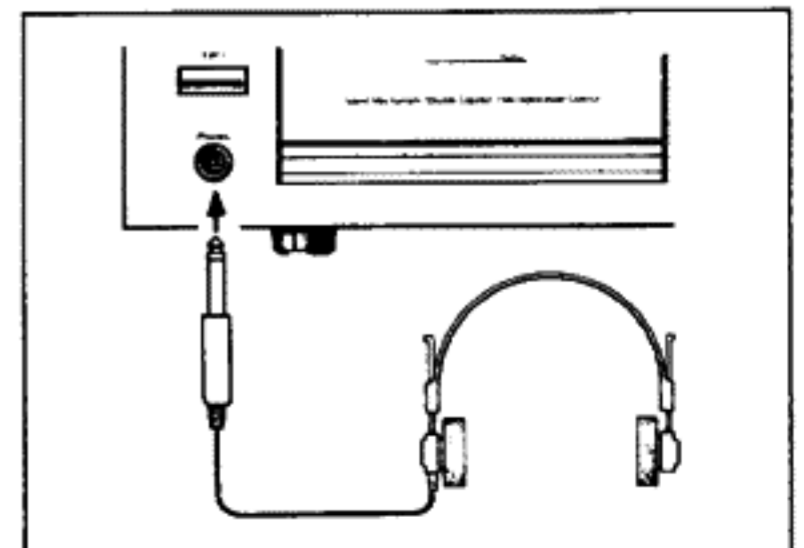

Connection of Microphone Amplifier

As the ZX-7 possesses only line input facilities, it is not possible to directly connect microphones to this deck. When microphones are to be used, a separate microphone amplifier, such as the optionally available MX-100 Microphone Mixer from Nakamichi's BlackBox series, is required.

As this deck provides a DC output jack (34) on the rear panel to power the MX-100, the power supply unit (PS-100) is not required.

MX-100 Microphone Mixer

For microphone recordings, we recommend the use of the MX-100 Microphone Mixer. This unit provides three inputs (left, right and center "blend") which can be mixed freely. For detailed instructions, please consult the instruction booklet supplied with the MX-100.

Note:

- The DC output jack on the deck's rear panel is designed for use with components from Nakamichi's BlackBox series only. Do not connect any other units to this jack. As the maximum capacity of this outlet is 125 mA, be careful that the total rated current consumption of units connected to this jack does not exceed 125 mA. If you wish to operate multiple BlackBox components which exceed 125 mA in total current consumption, a PS-100 Power Supply unit (rated capacity 200 mA) must be used.

Power Consumption of BlackBox Components

BlackBox Component	Current Rating
MX-100 Microphone Mixer	50 mA
EC-100 Electronic Crossover	100 mA

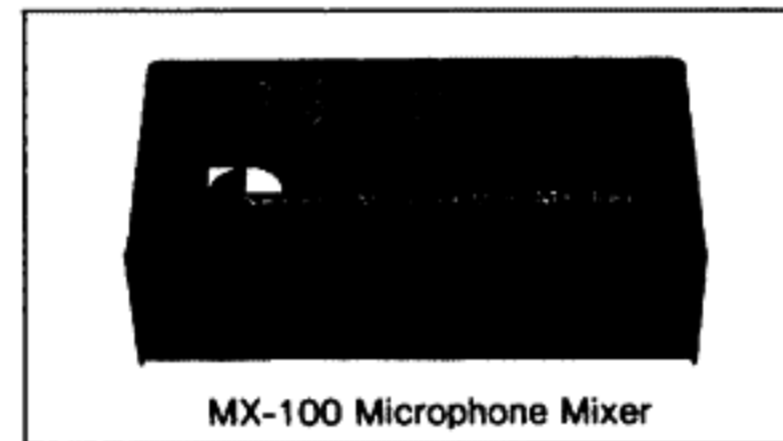
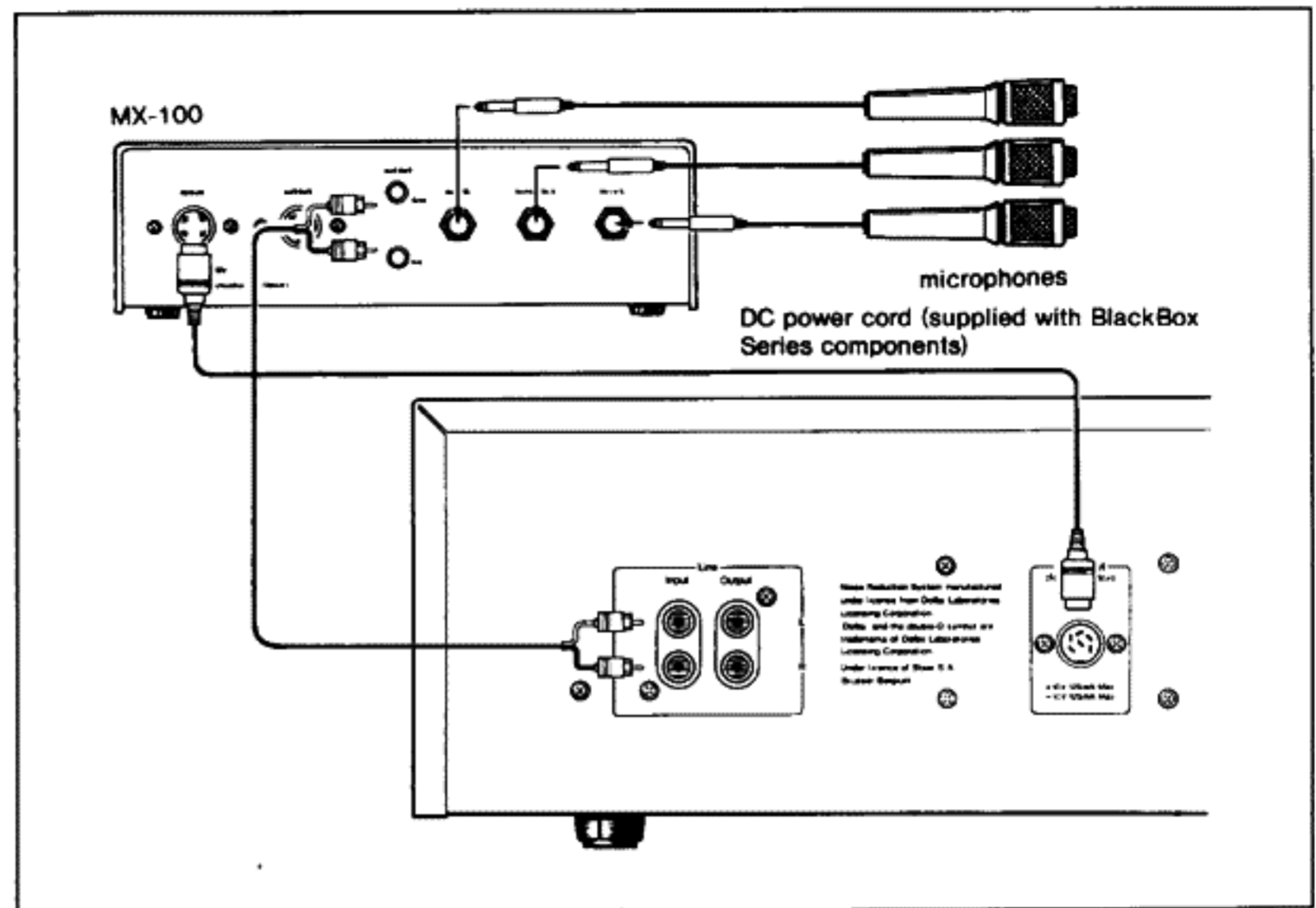

1. Master Fader Control

This feature permits smooth and easy fades during recording simply by pressing a button. Fade-in is performed by depressing the "Up ▷" side of the master fader control (14), and fade-out is performed by depressing the "Down ◁" side.

You can choose between two fading speeds: Depressing the button strongly (two clicking sounds of the switch) and keeping it depressed causes the fading process to be performed in about 2 seconds. Depressing the button lightly (one clicking sound of the switch) or releasing the button after one push causes the fading process to be performed in about 6 seconds.

The respective fading mode is indicated by the relative brightness of the indicator above the master fader control.

In ordinary music recording, slow-speed fading may be more desirable, while high-speed fading can be used effectively for example to eliminate noise when the cartridge is lowered onto a record, etc.

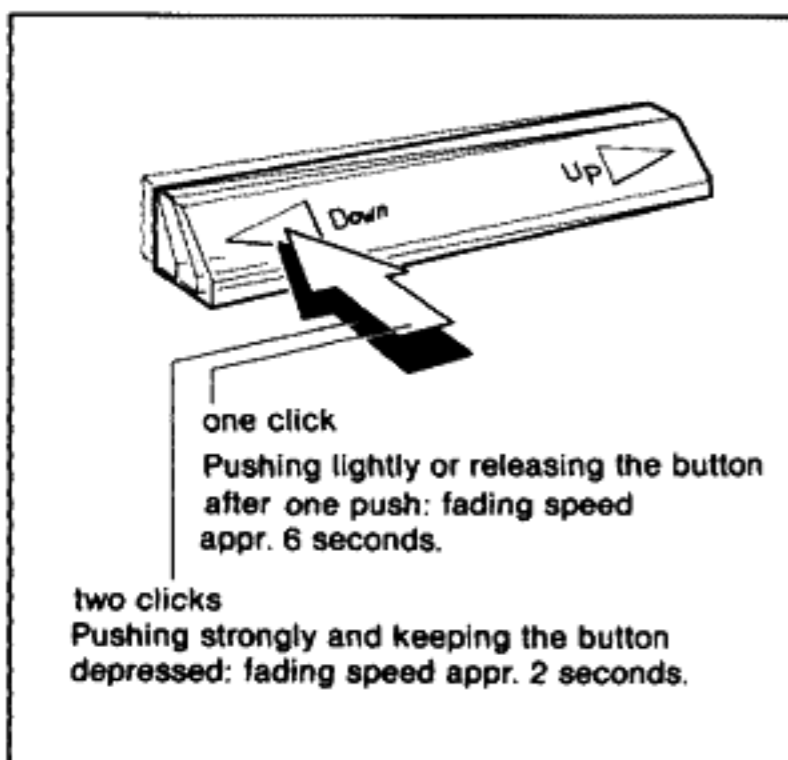

Note:

- The operation of the master fader control can be changed from "Up" to "Down" or from "Down" to "Up", but it can not be stopped midway.
- The master fader control is operative only in the record and record-standby modes. In other modes, the setting is automatically "Up".

2. Auto Play Feature

This feature is operated by means of the rewind button (8) or fast-forward button (12) and the record button (13). "Auto Play" means that the tape is stopped from rewind or fast-forward at the counter indication "0000" and the deck automatically starts playback from this point.

— Operation —

- (1) Press the counter reset button (2) at the beginning of a recording or playback to return the counter indication to "0000".
- (2) After recording or playback is completed, press the rewind button (8), lighting up the indicator above the button, and then — while keeping the rewind button depressed — press the record button (13). The tape will now be rewound to the "0000" indication and playback will automatically start from there. The auto play feature can also be activated while the deck is already in the rewind mode: just press the rewind button once again and then press the record button.

The above description is an example for the rewind mode, but the auto play feature can be operated in the same way in the fast-forward mode also.

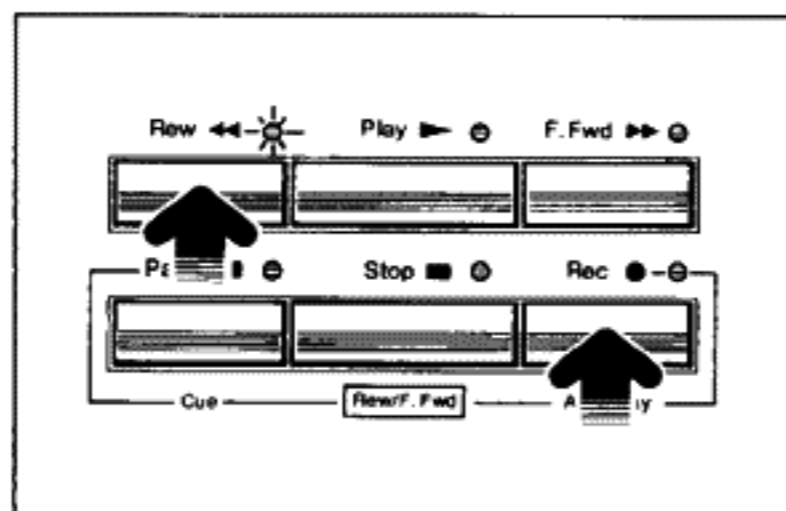

Note:

- Depressing the record button to activate the auto play feature does not light the record button indicator.
- When auto play is used, the deck starts playback at "0000", also when the tape start memory switch (30) is set to "Memory".

3. Rec Mute

By pressing the rec mute button (7) during recording, the input signal is cut off for as long as the button is being kept depressed. This can be used to insert silent spaces on a tape or suppress unwanted portions of a recording source. The indicator above the button lights up while the signal is cut off. When the monitor switch (26) is set to "Source", the line output and the headphone jack are not muted, so that it is possible to continuously monitor the input signal. The indicator above the rec mute button is set to display the condition when the recording signal current is cut off. Therefore the indicator lights up not only during rec mute operation, but also in the record-standby mode.

When entering the record mode from the stop mode, the rec mute indicator lights up for an instant, because the muting is activated until the heads touch the tape.

4. Cueing

Monitoring the high-pitched sounds from the tape while it is being fast-forwarded or rewound is called cueing. This can be used to locate the beginning of a musical selection, etc.

—Operation—

When the pause button (9) is depressed in the fast-forward or rewind modes (fast-forward or rewind button indicator lit), the head assembly is moved closer to the tape and winding speed is reduced to one-third, letting you hear the recorded signals from the tape.

When you approach the desired spot on the tape, you can further reduce winding speed to approximately one-sixth by pressing and holding the fast-forward or rewind button. If you have moved the tape too far in one direction, you can change the direction of tape travel while remaining in the cueing mode simply by pressing the opposite fast-winding button. Pressing both the fast-forward and rewind buttons simultaneously will stop the tape with the deck remaining in the cueing mode. If you release both buttons simultaneously, the deck goes into the pause mode, and playback can be started easily from this point by pressing the play button. The cueing mode can be released by pressing the stop button.

5. Punch-In Recording

Going from the playback mode directly into the record mode without pressing the stop button is called punch-in recording. This can be used to immediately start a recording from playback or to later insert another recording source on silent passages left in a previous recording, etc. Also, with this deck the record-standby mode can be entered directly from the pause mode without using the stop button.

—Operation—

In the playback mode, while depressing the play button (10), press the record button (13). In addition to the play button indicator, the record button indicator also lights up and recording starts without the tape motion being stopped.

Cueing (1)
Speed reduced to one-third in fast-forward or rewind

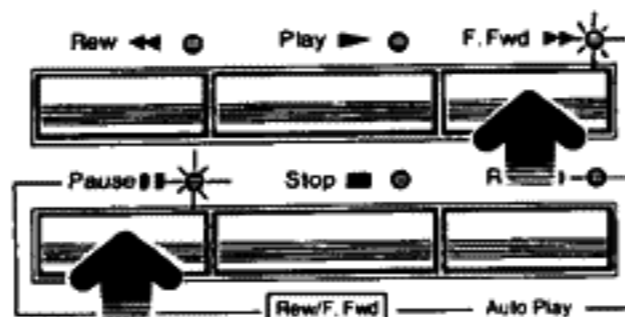

Cueing (2)
Speed reduced to one-sixth while button is kept depressed

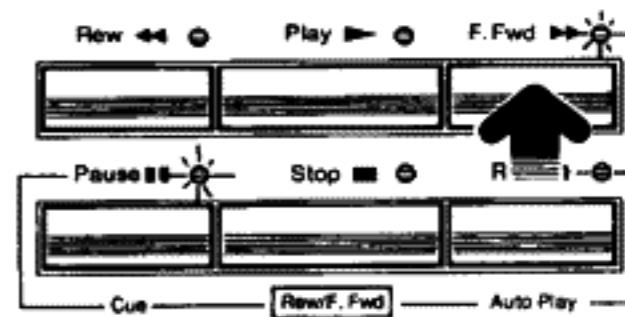

Cueing (3)
Change of direction

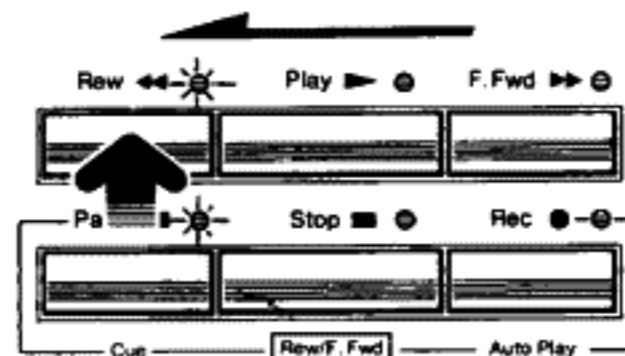

Cueing (4)
Pause mode is entered by releasing both buttons simultaneously from cueing stop

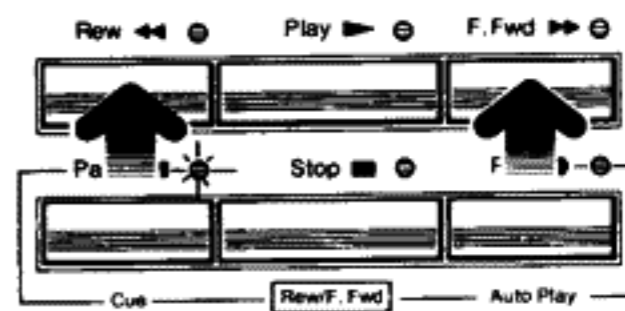

To enter the record-standby mode from the pause mode, press the record button (13) while depressing the pause button (9). The record button indicator flashes for about 2 seconds and then lights up continuously, indicating record-standby.

Note:

- If the tabs on the rear of the cassette are removed, it is not possible to enter the record mode.
- For punch-in recording, always press the play button (10) or the pause button (9) before you press the record button (13). If the record button is pressed first, the operation cannot be performed.

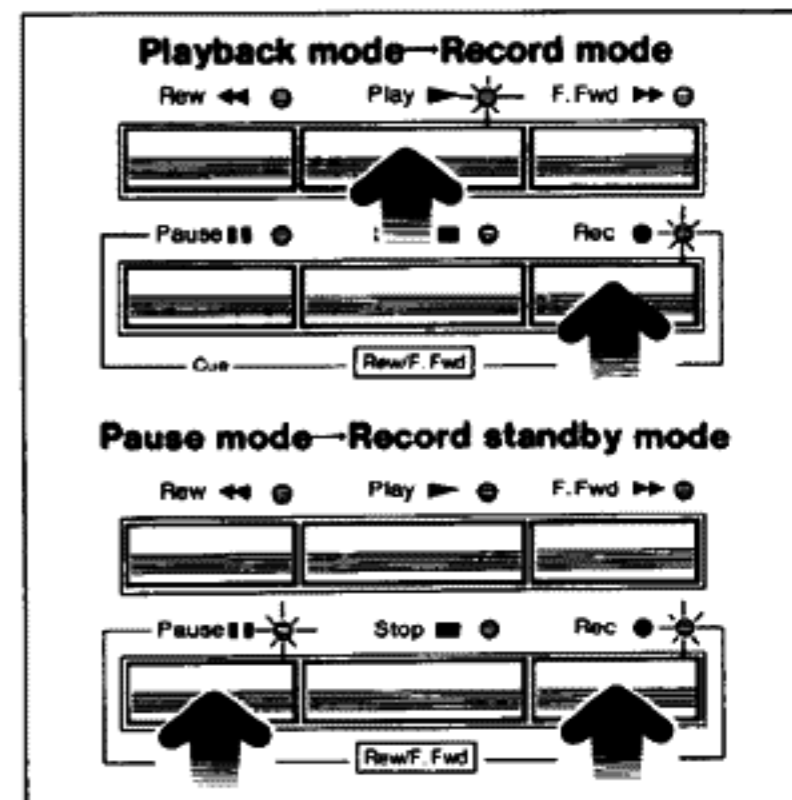

6. Timer Recording or Playback

This deck incorporates a self-start feature which enables you to make unattended recordings or start playback at a pre-selected time with the use of a timer.

—Operation—

1. Make connections as shown in the chart.
2. Insert the tape for recording or playback and turn on the power to all components.
3. For timer recording, set the recording level to suit the expected signal. For timer playback, set the output control to the desired level. Check if all components are set up properly.
4. For timer recording, set the tape start memory/timer switch (30) to "Rec", for timer playback, set it to "Play".
5. Adjust the timer to the desired starting time.
6. At the pre-selected time, the timer will supply power to the components and the ZX-7 will start recording or playing.

Note:

- When the timer recording or playback feature is not desired, be sure to set the tape start memory/timer switch (30) to "Off" or "Memory".

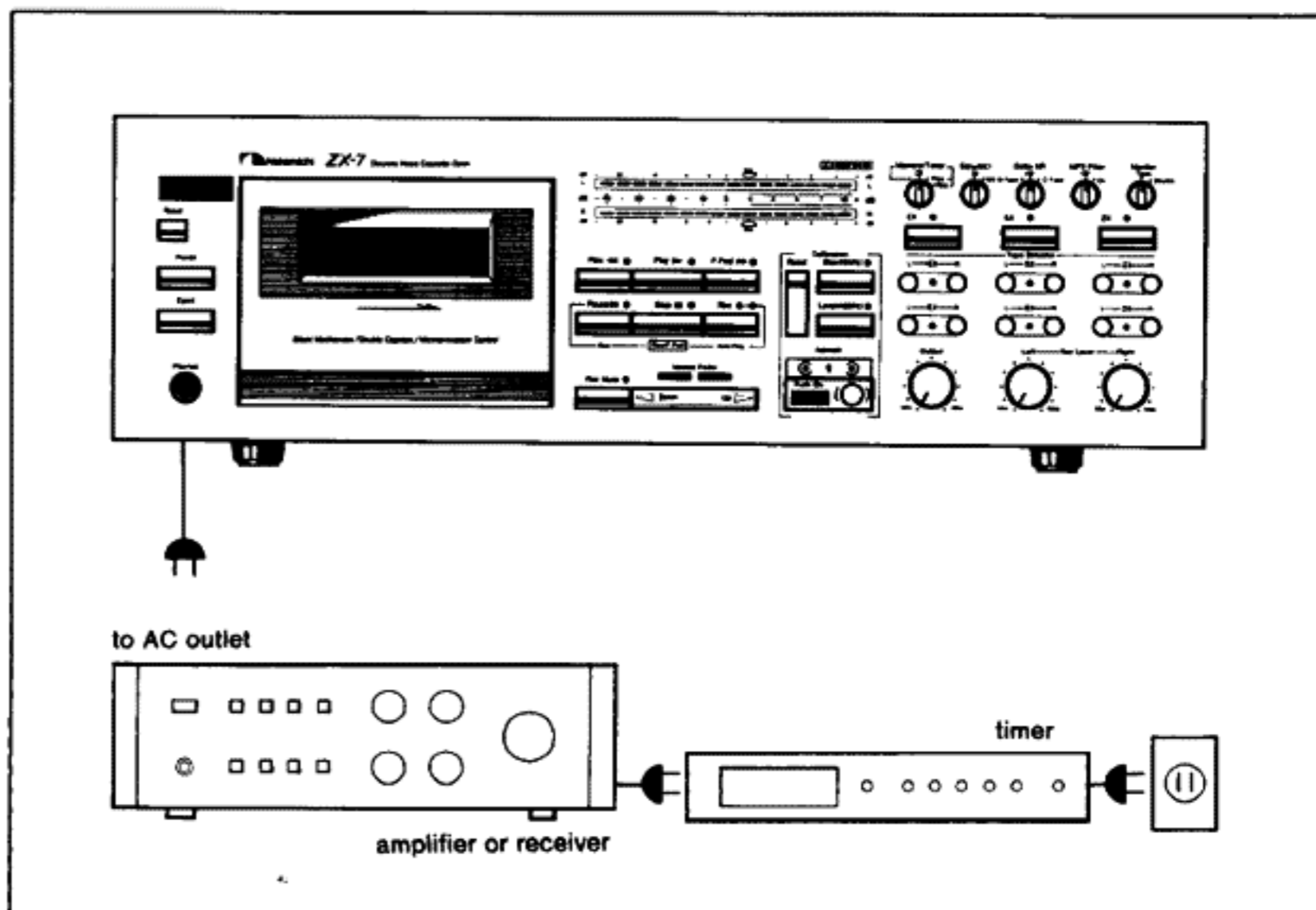

Playback

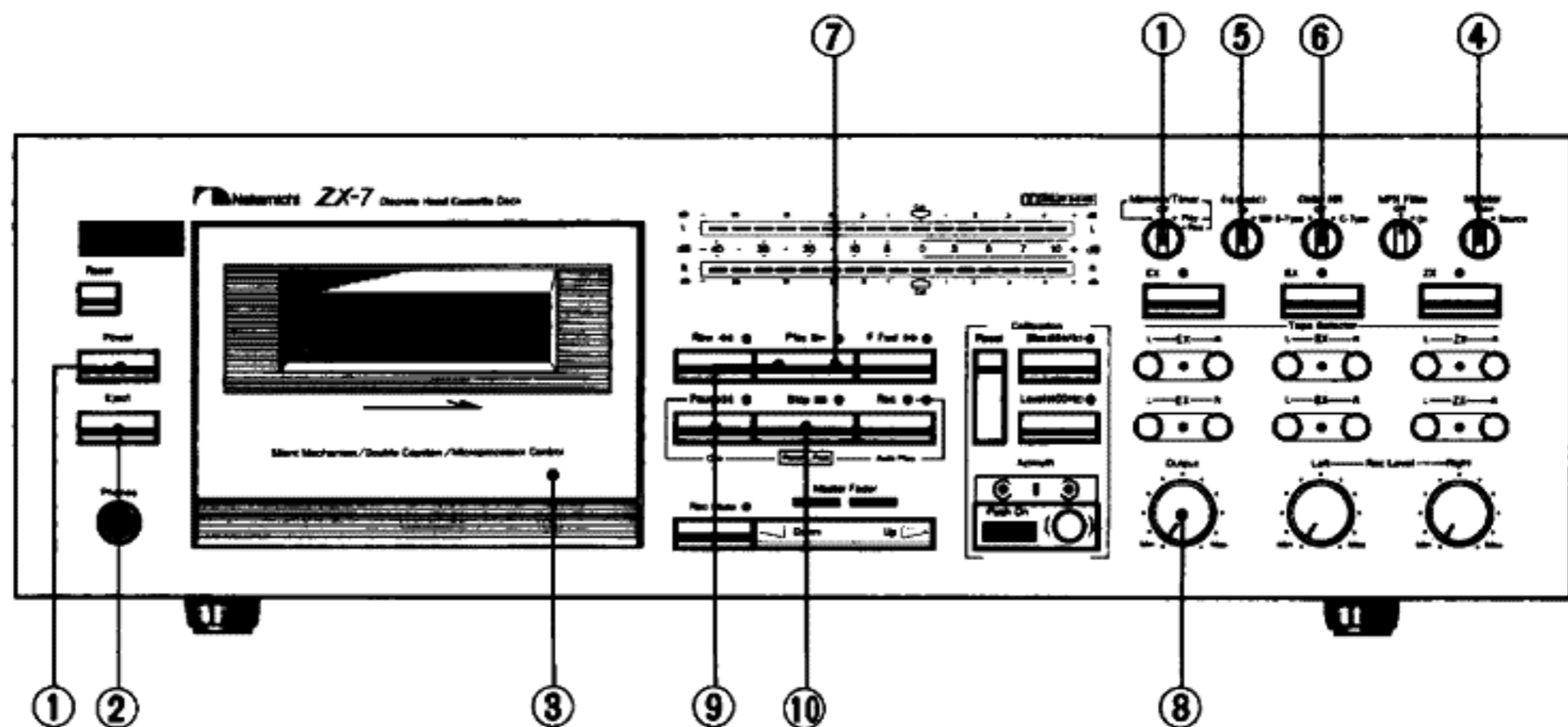

- ① Confirm that the tape start memory/timer switch (30) is not set to "Play" or "Rec". Turn on the power to the deck by depressing the power switch (3).
- ② Open the cassette holder (6) by depressing the eject button (4).
- ③ Insert the cassette into the holder with the exposed tape facing down and the desired side facing outwards. Push the cassette holder back until it locks into the panel.
- ④ Set the monitor switch (26) to "Tape".
- ⑤ Set the Eq switch (29) to 120 μ s or 70 μ s, according to the tape used. (→p. 12)
- ⑥ When playing back a tape which was recorded with Dolby B-Type noise reduction, set the Dolby NR switch (28) to "B-Type". When playing back a tape which was recorded with Dolby C-Type noise reduction, set the switch to "C-Type".
- ⑦ Press the play button (10).
- ⑧ Adjust the output level control (21) to the desired level.
- ⑨ For short-term interruption of playback, press the pause button (9). To resume playback, press the play button (10) again.
- ⑩ To stop the tape altogether, press the stop button (11).
- ⑪ When the tape end is reached, the tape transport is shut off automatically.

Note:

- Ordinary Dolby-encoded tapes, which were not recorded with Dolby C-Type noise reduction, are to be played back at the "B-Type" position.
- The transport of this deck, permits going from any transport mode into any other (i.e. from play to rewind, from rewind to fast-forward, etc.) without having to use the stop button.
- While the tape is in motion or in the pause mode, the eject button is inoperative and the cassette holder does not open even if the button is depressed. While the cassette holder is open, logic circuitry prevents operation of all transport modes.
- During playback, the deck's peak level meters display the level recorded on the tape. Readings are not affected by turning the output level control.

Be sure to read this paragraph and perform the respective adjustments before starting to record.

There are many brands of cassette tapes, which can be generally classified into three types: chrome-equivalent tapes, normal tapes (ferric-oxide formulations) and metal tapes. Tapes from the list on this page can be used with this deck simply by setting the tape selector buttons (25) and the Eq switch (29) to the appropriate positions. However, even with tapes of the same brand, there are certain individual tolerances. In order to perfectly match the deck to the tape and extract full performance, the ZX-7 provides manual adjustment facilities for record head azimuth, sensitivity (record/play level, calibration) and bias current. The manual adjustment process is aided by a microprocessor, which makes for easy and simple operation.

Tape Selector Button and Eq Switch Settings (Recommended Tapes)

EX/120 μ s Position

Tape Selector Buttons, Eq Switch	Brand Name
	Nakamichi EX, EX II TDK AD, OD Maxell UD, UDXL-I Fuji FX-I AMPEX GM-I

SX/70 μ s Position

Tape Selector Buttons, Eq Switch	Brand Name
	Nakamichi SX TDK SA Maxell UDXL-II Fuji FX-II AMPEX GM-II

ZX/70 μ s Position

Tape Selector Buttons, Eq Switch	Brand Name
	Nakamichi ZX TDK MA, MA-R Maxell MX Fuji Metal AMPEX MPT

Note: — This deck is not suited for use with ferri-chrome cassettes
 — Press the tape selector buttons firmly and confirm that the appropriate indicator is lit.

Manual Calibration Point

(1) Azimuth Alignment

Azimuth is the degree to which the gap of a magnetic head is perpendicular to the path of tape travel. In the case of cassette tapes, the cassette housing determines tape travel characteristics, and even slight housing variations can cause azimuth misalignment, which degrades high-frequency response and phase characteristics. Therefore, be sure to perform azimuth alignment every time you change cassettes.

The alignment is performed using the built-in test tone of 400 Hz (0 dB).

(2) Level Calibration

This calibration corrects different levels in recording and playback which are due to sensitivity differences of various tapes. If level differences remain uncorrected, they can cause malfunction of the noise reduction system and degrade sound quality. Therefore you should perform this calibration when you change to a cassette of another brand even if it is to be used at the same tape selector position (for example change from the normal position Nakamichi EX to EX II, etc.). If exactly the same brand of cassette is used continuously, repeated calibration is not necessary. The calibration is performed using the built-in test tone of 400 Hz (0 dB).

(3) Bias Calibration

Bias is an inaudible high-frequency current used in the recording process. When bias is increased, distortion decreases but high-frequency response declines. On the opposite, when bias is decreased, distortion rises but high-frequency response improves. By means of the tape selector buttons (25), the appropriate bias range for normal, chrome-equivalent or metal tapes is chosen, and the bias controls (24) permits fine adjustment. Different brands of cassettes have slightly different bias requirements even if they are of the same general type. Therefore you should perform bias calibration every time another brand of cassette is used. Only when the same tape is used continuously, repeated bias calibration is not necessary. The calibration is performed using the built-in test tone of 15 kHz (-20 dB).

■ Calibration Procedure

1. Order of Calibration

When azimuth, level and bias calibration are to be performed, or for bias calibration, observe the following order:

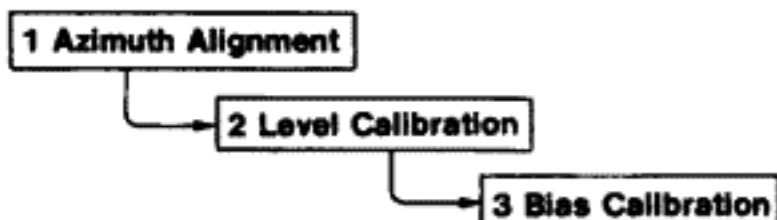

Azimuth alignment, level calibration or bias calibration can also be performed separately. For example, if bias and level calibration have already been completed for a certain tape, it suffices to perform only azimuth alignment. As even different samples of the same brand of cassette exhibit certain variations, azimuth alignment should be performed every time a tape is inserted into the deck for recording.

2. Calibration

1 Azimuth Alignment

- (1) Confirm that the tape start memory/timer switch (30) is not set to "Play" or "Rec". Turn on the power to the deck by depressing the power switch (3).
- (2) Insert the tape to be used for recording.
- (3) Set the Dolby NR switch (28) to "Off" and select the appropriate tape selector button (25) and the appropriate position of the Eq switch (29) for the tape. (→p. 12)
- (4) While keeping the record button (13) depressed, press the pause button (9) to put the deck into the record-standby mode.
- (5) Set the monitor switch (26) to "Tape".
- (6) Press the azimuth alignment start button (16). The deck goes from record-standby into the record mode. At the same time, the tape counter (1) is automatically reset to "0000" and the indicator above the level calibration start button (19) lights up. (This is because the level calibration test tone of 400 Hz 0 dB is used for azimuth alignment also.) Next, one of the azimuth indicators lights up to signal readiness for azimuth alignment.

Note:

- If a wrong tape selector button was pushed or record/playback is not possible for any reason, the azimuth indicators do not light up. (→p. 15)

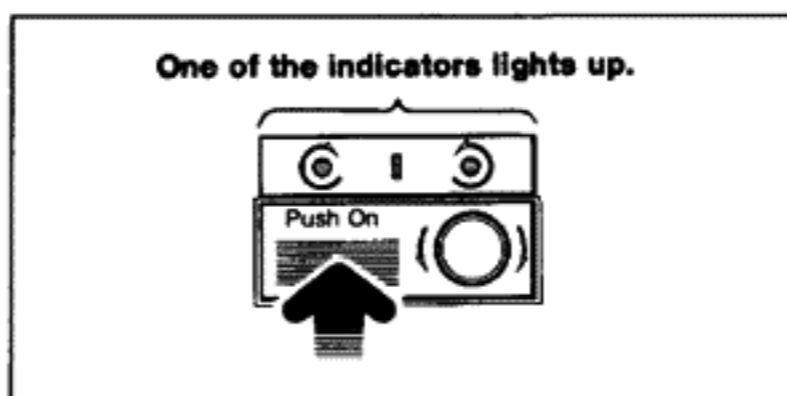

- (7) If only the red indicator in the center is lit, azimuth alignment is not necessary. If one of the green azimuth indicators (left or right) is lit, adjust the azimuth by turning the azimuth alignment knob (17).
 - **Right azimuth indicator is lit:**
Turn the azimuth alignment knob slowly to the left (counterclockwise), until the red indicator in the middle is lit.
 - **Left azimuth indicator is lit:**
Turn the azimuth alignment knob slowly to the right (clockwise), until the red indicator in the middle is lit.

Note:

- Depending on the tape used, sometimes it may not be possible to light up only the center red indicator even if the alignment knob is turned. In such a case, the red indicator and one of the green indicators will flash in turn, which can also be taken as a sign that the alignment procedure is completed.
- Always turn the azimuth alignment knob very slowly without using too much force.

- (8) ■ **If level calibration is to be performed next, proceed as follows.**

Release the azimuth alignment start button (16) by pressing the button once more. The indicator between the sensitivity controls (23) corresponding to the position selected by the tape selector buttons (25) lights up and the peak level meters (31) display the test tone.

The indicator above the level calibration start button (19) stays lit because the 400 Hz test tone is being continuously used also after completion of azimuth alignment.

Now proceed to step (3) of "Level Calibration".

- **If you wish to perform only azimuth alignment, complete the procedure as follows:**

Release the azimuth alignment start button (16) by pressing the button once more. Then press the calibration reset button (15). This releases the record mode, the tape stops and then is automatically rewound to the starting point of calibration (tape counter indication "0000"). The azimuth alignment procedure is now completed.

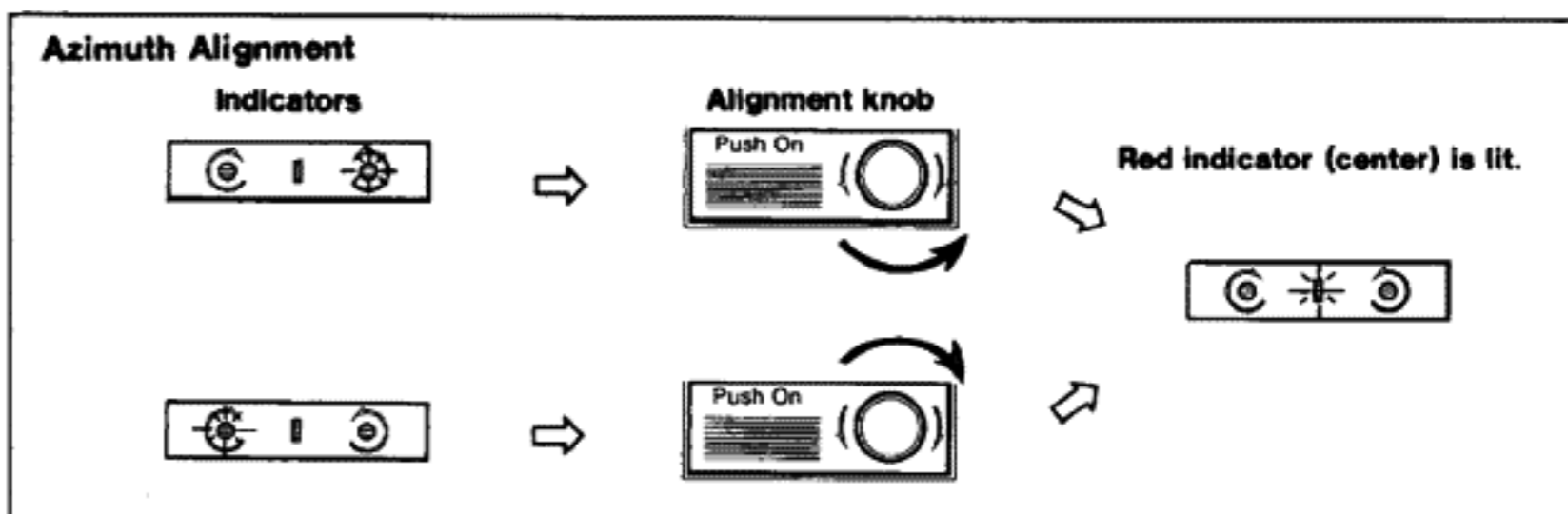

2 Level Calibration

- (1) Perform steps (1)~(5) of "Azimuth Alignment".
- (2) Press the level calibration start button (19). The indicator above the button lights up and the deck goes from record-standby into the record mode. At the same time, the tape counter (1) is automatically reset to "0000". When the tape has started moving, the indicator between the sensitivity controls (23) corresponding to the position selected by the tape selector buttons (25) lights up and the peak level meters (31) display the record/playback level of the 400 Hz (0 dB) test tone.
- (3) If the meter indication is lower than the LED marked "Cal." on the outer scale of the peak level meters (31), turn the respective sensitivity control (23) clockwise, and if meter indication is higher, turn it counterclockwise until the meter reading is at the "Cal." point for both left and right channels.
- (4) ■ **If bias calibration is to be performed next, proceed as follows.**

Press the bias calibration start button (20). The indicator above the button and the indicator between the bias controls (24) corresponding to the position selected by the tape selector buttons (25) light up. The test tone changes from 400 Hz (0 dB) to 15 kHz (-20 dB) and is displayed on the peak level meters with increased sensitivity.

Now proceed to step (3) of "Bias Calibration".

- **If you wish to perform no further adjustment after level calibration, complete the procedure as follows.**

Press the calibration reset button (15). This releases the record mode, the tape stops and then is automatically rewound to the starting point of calibration (tape counter indication "0000"). The level calibration procedure is now completed.

Level Calibration

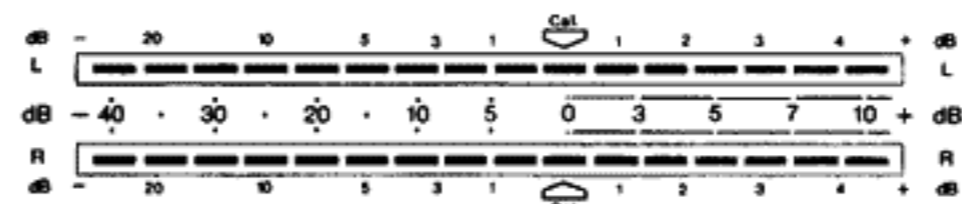

Turn counterclockwise if meter reading is above "Cal." point.

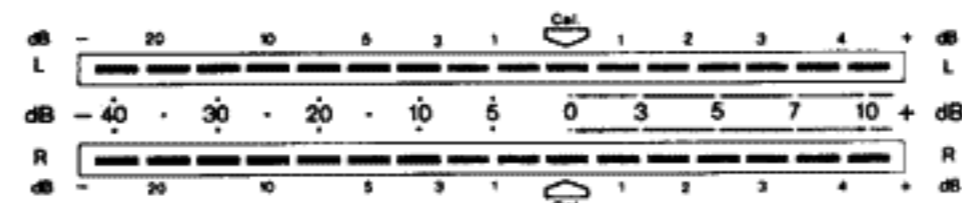

Turn clockwise if meter reading is below "Cal." point.

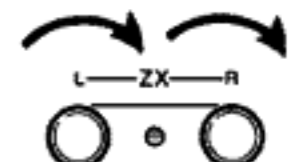

3 Bias Calibration

- (1) Perform steps (1)~(5) of "Azimuth Alignment".
- (2) Press the bias calibration start button (20). The indicator above the button lights up and the deck goes from record-standby into the record mode. At the same time, the tape counter (1) is automatically reset to "0000". When the tape has started moving, the indicator between the bias controls (24) corresponding to the position selected by the tape selector buttons (25) lights up and the peak level meters (31) display the record/play level of the 15 kHz (-20 dB) test tone with increased sensitivity.

- (3) If the meter indication is higher than the LED marked "Cal." on the outer scale of the peak level meters (31), turn the respective bias control counterclockwise, and if meter indication is lower, turn it clockwise until the meter reading is at the "Cal." point for both left and right channels.

- (4) Press the calibration reset button (15) to terminate the calibration process. The record mode is released, the tape stops and then is automatically rewound to the starting point of calibration (tape counter indication "0000"). The bias calibration procedure is now completed.

Bias Calibration

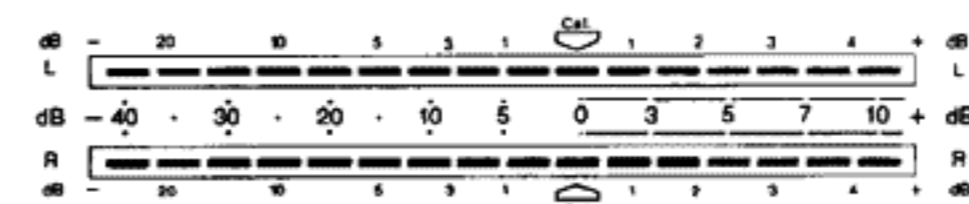

Turn counterclockwise if meter reading is above "Cal." point.

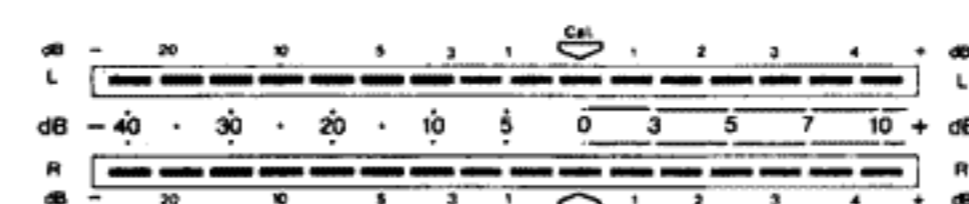

Turn clockwise if meter reading is below "Cal." point.

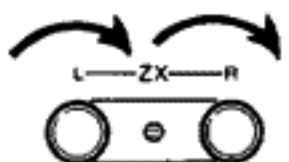
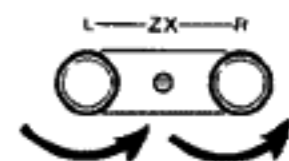

■ Ordinary Calibration Cannot Be Performed

If due to some reason the settings of the bias and sensitivity controls were greatly disturbed, it is possible that sound quality upon recording/playback is vastly impaired or the azimuth indicators do not light up, making azimuth alignment and ordinary calibration impossible. In such a case, first perform a rough adjustment of level and bias as described below.

Rough Adjustment

1. Confirm that the correct tape selector button (ZX, SX or EX) is pushed for the tape in use.
2. Turn the bias controls corresponding to the selected tape type fully counterclockwise. (maximum bias current).
3. Turn the sensitivity controls corresponding to the selected tape type fully clockwise.

4. Press the azimuth alignment start button and perform azimuth alignment.
5. Release the azimuth alignment start button and perform level calibration. Adjust the sensitivity controls so that the indication of the peak level meter becomes -1 dB -0 dB for both channels.
6. Push the bias calibration start button and adjust the bias controls so that peak level meter indication is at the "Cal" point for both channels.

This completes the rough adjustment of level and bias. Now you can perform regular calibration, starting with azimuth alignment.

Use of the Test Tone

The built-in test tone can be used not only for azimuth alignment and record/playback level and bias calibration, but also for level calibration with other audio components.

-Operation-

- Turn the output level control (21) to "Max." and set the monitor switch (26) to "Source".
 - When the 400 Hz (0 dB) test tone is to be used, press the level calibration start button (19). When the 15 kHz (-20 dB) test tone is to be used, press the bias calibration start button (20). The respective test tone is now fed out from the output jacks and is also displayed on this deck's peak level meters. (The 15 kHz test tone is produced and fed out at -20 dB , but it is displayed on the meters with increased sensitivity.)
- To switch off the test tone, press the calibration reset button (15).

■ Some Precautions on Calibration

1. Bias calibration and level calibration are performed with the test tone being recorded and the results being displayed on the peak level meters in the "Tape" position of the monitor switch. If the switch is set to "Source" or in other modes (playback), the test tone is not displayed.
2. If a low-quality tape is used, the high-frequency output may not increase even if bias current is decreased (the bias controls are turned clockwise). Rather, in such a case, distortion only will increase. Therefore it is highly recommended that you use tapes from the list on page 12.
3. While the test tone is used, you should turn down the volume control on your amplifier, because excessive high-frequency levels can cause damage to your speakers.
4. During calibration or use of the test tone, the master fader control is in the "Down" position and the line input is automatically cut off.
5. When the azimuth alignment start button (16) is depressed (on), the line output is muted and no sound is heard. Be sure to return the button to the released (off) position when alignment is not being performed.
6. Due to temperature influences, the level of the built-in test tone (400 Hz, 15 kHz) may vary slightly at times. To perform very exact level and bias calibration, set the monitor switch to "Source" while the test tone is being displayed and check the actual indication. Then return the monitor switch to "Tape" and perform the calibration in such a way that the meter readings in the "Tape" position are the same as in the "Source" position.

Manual Calibration Flow Chart

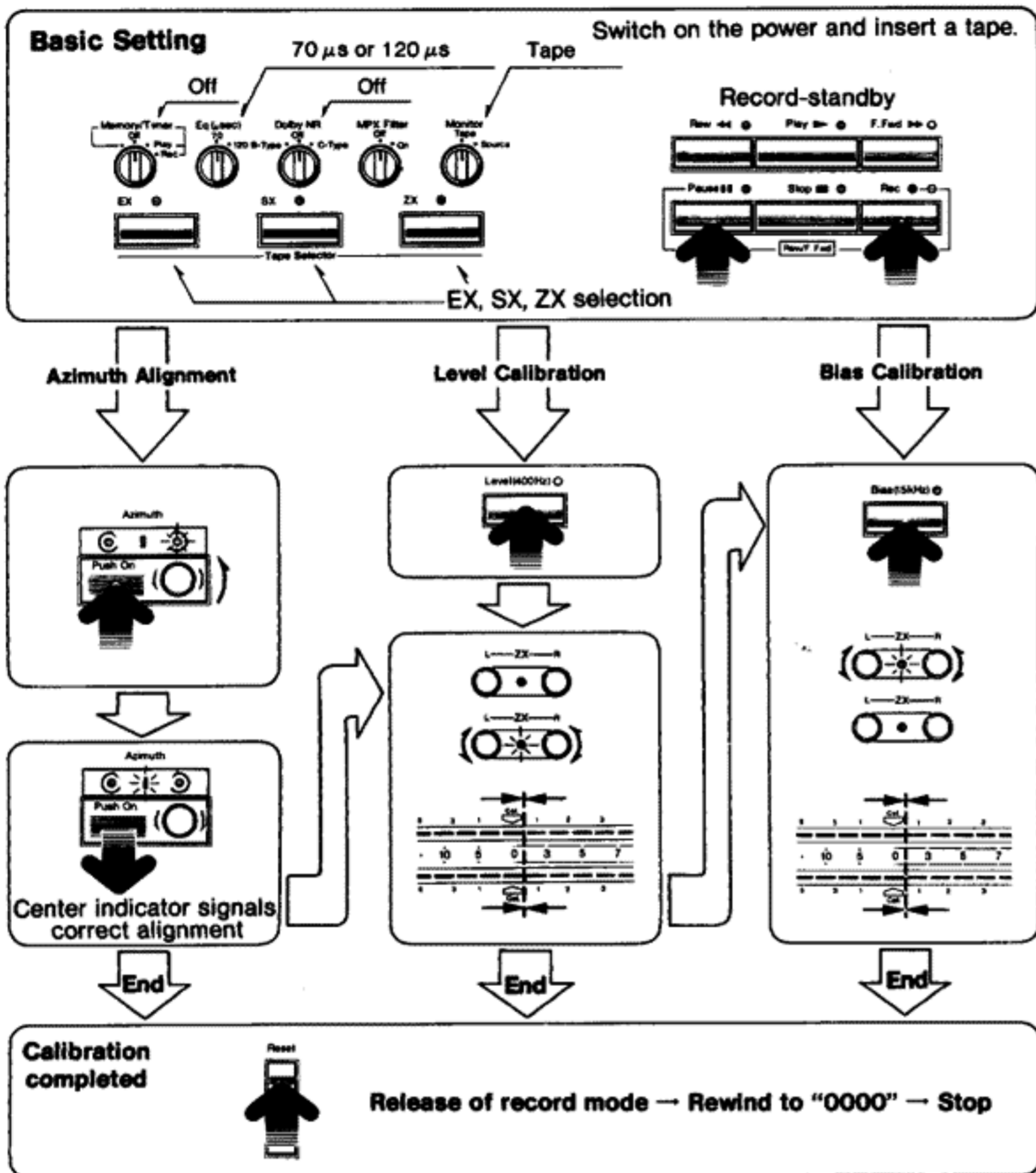

The Nakamichi T-100 Audio Analyzer (optional) is a most useful tool for all kinds of tape deck adjustments and measurements. With one T-100 it is possible to perform measurement and adjustment of frequency response, distortion, wow-and-flutter, etc.

T-100 Audio Analyzer



Recording

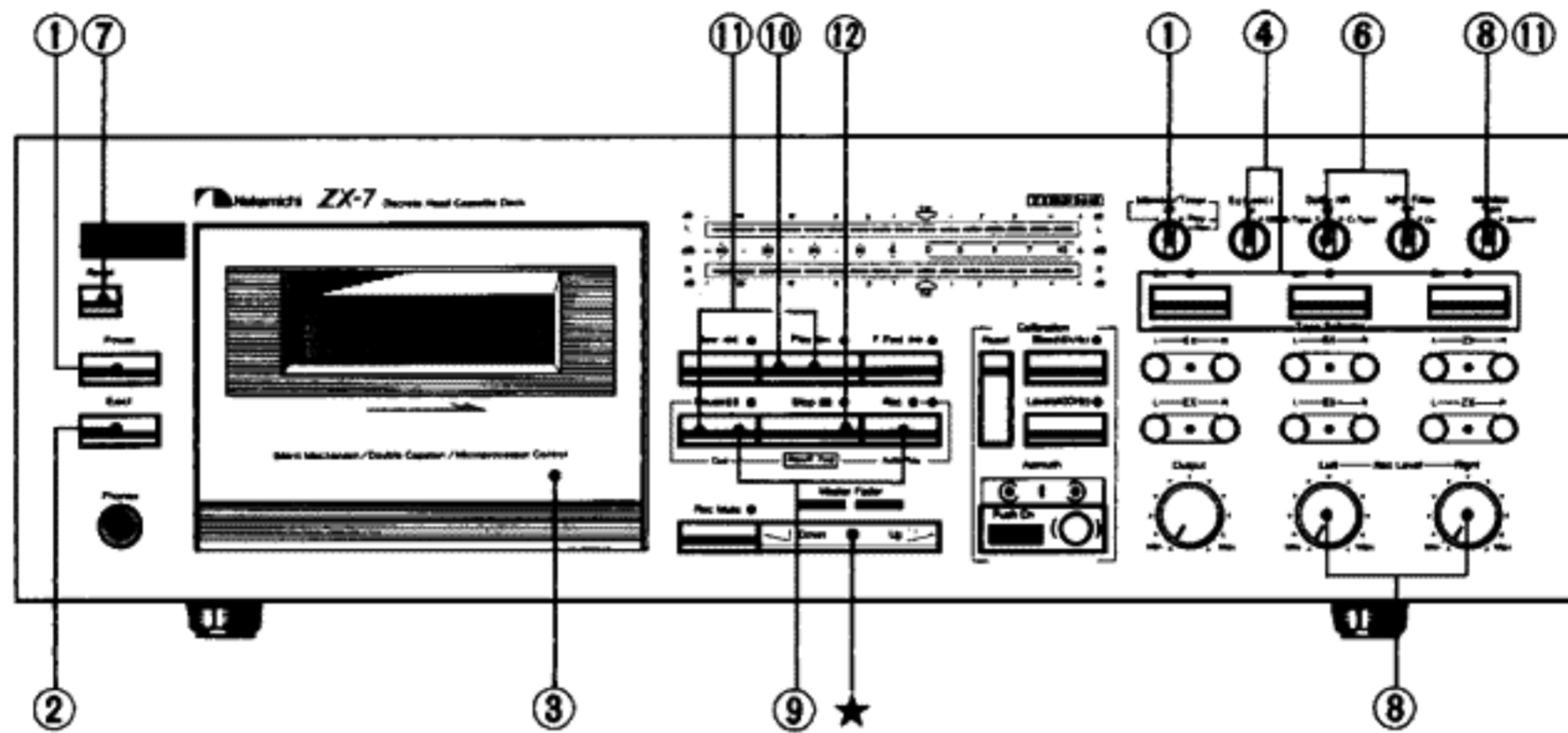

- ① Confirm that the tape start memory/timer switch (30) is not set to "Play" or "Rec". Turn on the power by depressing the power switch (3).
- ② Open the cassette holder (6) by depressing the eject button (4).
- ③ Insert the cassette to be used for recording into the holder with the exposed tape facing down. Push the cassette holder back until it locks into the panel.
- ④ Select the appropriate tape selector button (25) and position of the Eq switch (29) for the tape in use. (→p. 12)
- ⑤ Has calibration been performed for the tape in use? If not, refer to page 12, "Before Recording" and perform the respective calibrations.
- ⑥ If the Dolby NR system is to be used in recording, select the desired position of the Dolby NR switch (28), either "B-Type" or "C-Type". If the Dolby system is not to be used, set the switch to "Off". When recording from FM broadcasts, set the MPX filter switch (27) to "On".
Note:
— When recording from other program sources except FM broadcasts, the MPX filter switch should be set to "Off".
- ⑦ By pressing the counter reset button (2) to return the tape counter indication to "0000" and setting the tape start memory/timer switch (30) to "Memory", you can easily return to the starting point after recording is completed. The tape will stop automatically at the counter indication "0000" in rewind.

- ⑧ Set the monitor switch (26) to "Source" and, while watching the peak level meters (31), adjust the input level controls L,R (22) to obtain the correct recording level. (→p. 18)
- ⑨ While keeping the record button (13) depressed, press the pause button (9) to bring the deck into the record-standby mode. The red indicator above the record button and the green indicator above the pause button light up.
★ If you want to start the recording with a fade-in, press the "Down ◁" side of the master fader control (14) to return the fader to minimum.
- ⑩ Press the play button (10) to start recording.
★ To perform fade-in, now press the "Up ▷" side of the master fader control (14). The recording level is automatically brought up to the level determined in step ⑧.
- ⑪ To check the quality of the recording in progress, you can instantly monitor the playback signal by setting the monitor switch (26) to "Tape". In the "Source" position, the input signal before recording is heard.
For short-term interruption of recording, press the pause button (9). To resume recording, press the play button (10) again.

- ⑫ By pressing the stop button (11), the recording mode is released and the tape transport comes to a full stop.
★ If you want to end the recording with a fade-out, press the "Down ◁" side of the master fader control (14) to return the fader level to minimum and then press the stop button. After the stop button was pushed, the master fader control is automatically released and the level returns to the "Up ▷" value.

Tips on Setting Record Levels

The LED level meters of this cassette deck are free of "overshoot" problems and display peak levels with a high degree of accuracy. For good recordings, it is essential to maintain a high signal-to-noise ratio. This is achieved by putting as much signal on the tape as is possible without producing distortion. Setting record levels too low will result in noisy recordings, while too high recording levels cause distortion. Finding the proper level between these two extremes is what good recording is all about. This task is facilitated by this deck's level meters which cover a wide 50 dB range and accurately display even very short signal peaks. Refer to the chart as a guideline to set recording levels.

"Normal" (LH) position tape formulations,

"Chrome" position tape formulations:

The meters should be allowed to read as high as +5 dB on short program peaks.



"Metal" position tape formulations:

The meters should be allowed to read as high as +8 dB on short program peaks.

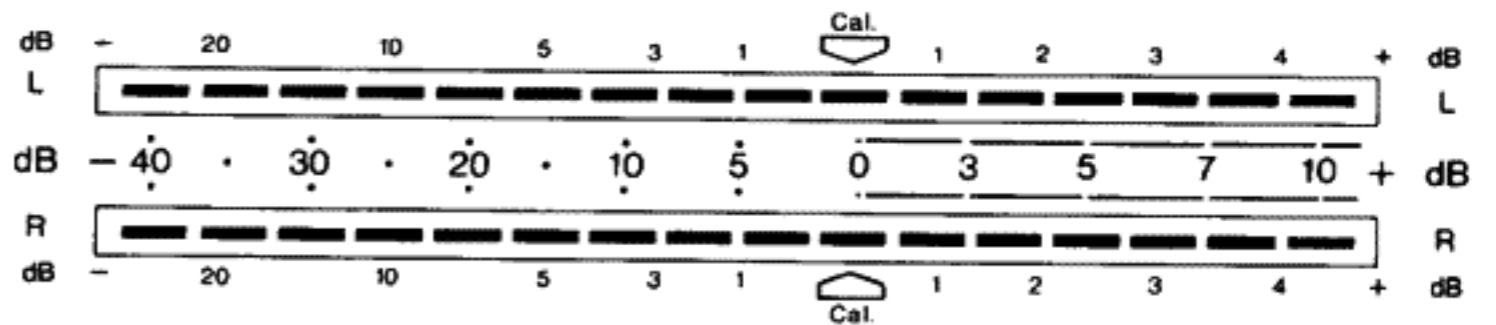

As different tape formulations have slightly different overload (headroom) characteristics, the requirements may vary to a certain degree when using different tapes.

Dolby Noise Reduction System

This deck uses the Dolby noise reduction (NR) system, but with a difference: In addition to the Dolby B-Type noise reduction built into conventional cassette decks, it incorporates the newly developed Dolby C-Type noise reduction system.

Whereas the Dolby B-Type NR reduced noise in the high frequencies by about 10 dB, the Dolby C-Type NR with new characteristics achieves an improvement of about 20 dB in the range from 2 kHz to 8 kHz, where noise is most readily audible.

The operating principle of the Dolby C-Type NR is similar to the B-Type, in that it does not affect high-level signals in recording, but processes only low-level signals in the mid and higher frequency range. However, the operation of the C-Type system starts at a point 2 octaves lower than with the B-Type system, and it incorporates new circuits to prevent encode/decode errors or high frequency loss due to tape saturation. By using the Dolby C-Type NR, dynamic range is greatly enhanced and the setting of record levels becomes easy and trouble-free. This deck incorporates both the Dolby B-Type and the Dolby C-Type noise reduction systems. When playing back a tape from your collection which was recorded with the B-Type NR "on", the NR switch should be set to the "B-Type" position. When playing a tape recorded with the C-Type NR, the switch should be set to the "C-Type" position.

Note:

- This system does not reduce any noise already contained in the incoming input signal. You should therefore strive to use signals as noise-free as possible as a recording source.

To the ear, the Dolby C-Type NR system provides a constant noise reduction with any type of music, during signal as well as during silent passages. Modulation or breathing noise has been suppressed past audibility, and the tape's saturation level is increased by the action of the so-called "spectral skewing circuit" to determine pre-emphasis and de-emphasis, and the "Anti-Saturation Network (ASN)", etc.

Chart A illustrates the low-level encoding characteristics for the B-Type NR and the C-Type NR. Decoding is done with exactly opposite characteristics, thus achieving flat overall frequency response. As can be seen from the chart, the operation threshold of the C-Type is two octaves lower than that of the B-Type, and in the high frequency range, noise reduction is by 20 dB.

Chart B shows an example of actual frequency response and noise spectrum analysis as recorded on a cassette deck. It is evident from the noise spectrum analysis that with the C-Type NR noise is considerably lower than with the B-Type and that it is reduced by about 20 dB in the range from 2 kHz to 8 kHz. In addition, with the C-Type NR, the ASN and skewing features etc. serve to increase high frequency MOL during high-level recording.

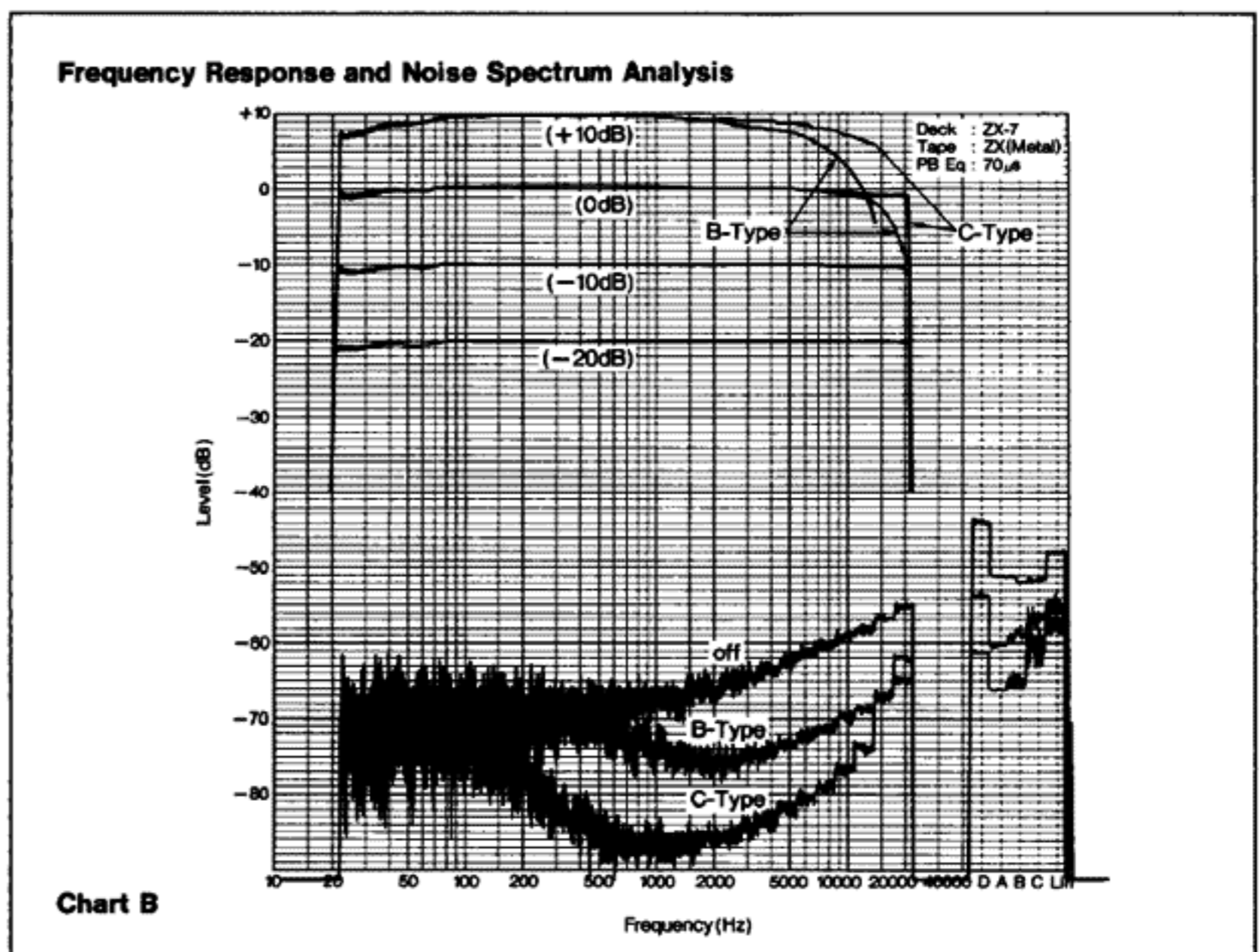
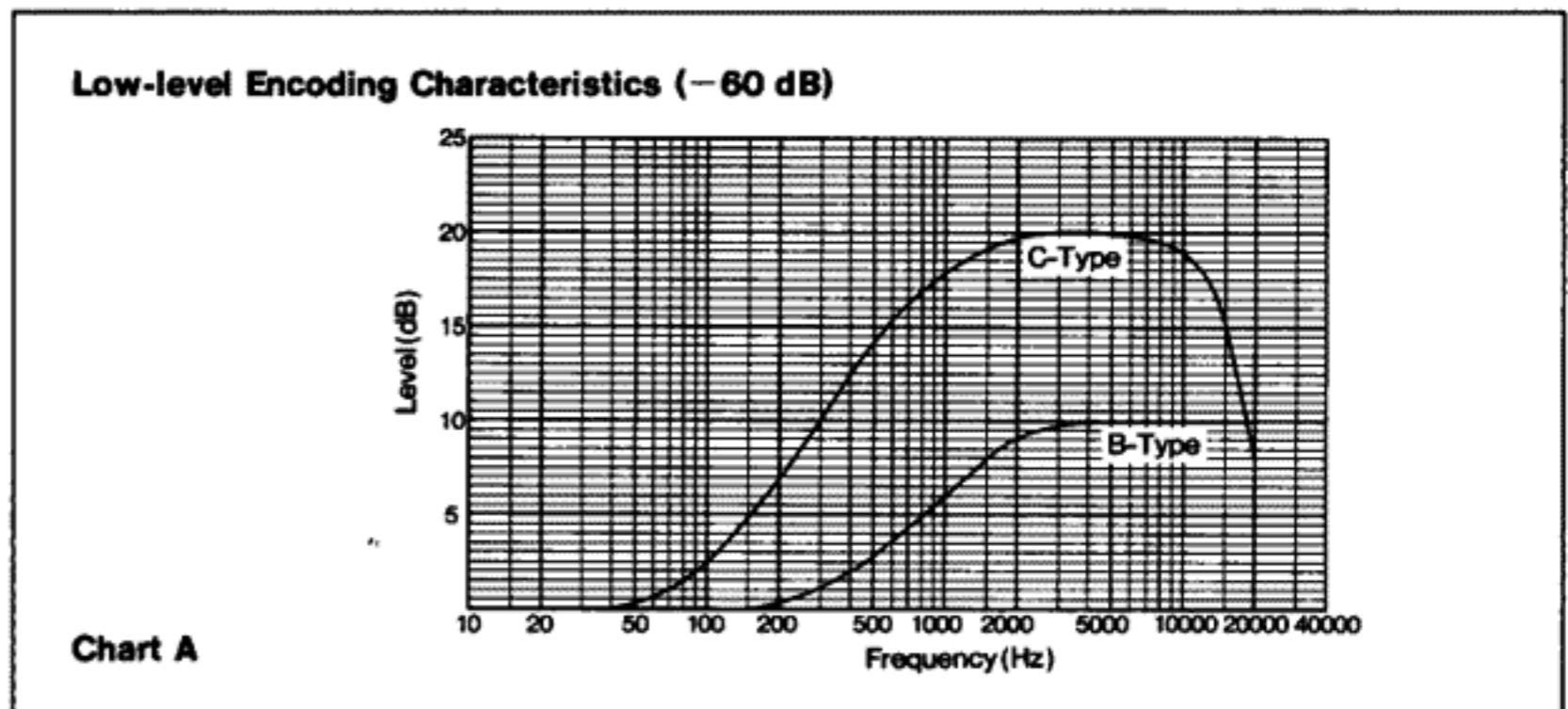

The cassette holder cover of this cassette deck can be easily removed. Perform cleaning or demagnetizing after removing the cover. In ordinary use, this cover should always be attached.

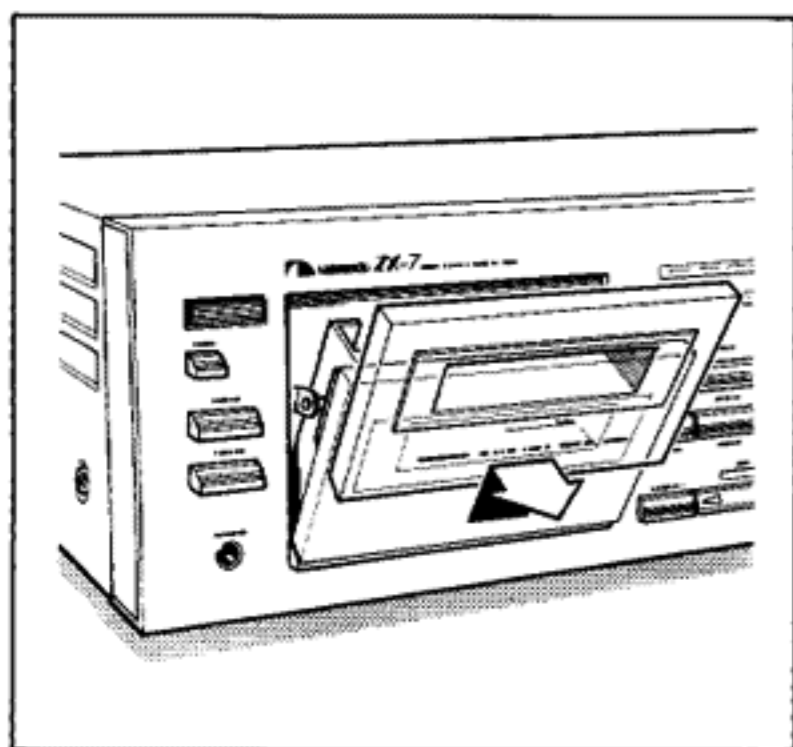

Head and Transport Cleaning

It is very important to regularly clean the surfaces of the record head, playback head and erase head as well as the capstans, pinchrollers and all other parts which come in contact with the tape. Tiny particles shedded from the tape onto these parts, as well as dust accumulations etc. become the cause of drop-outs, and severely degrade frequency response and wow-and-flutter characteristics. Be sure to always keep the parts shown in white on the illustration spotlessly clean.

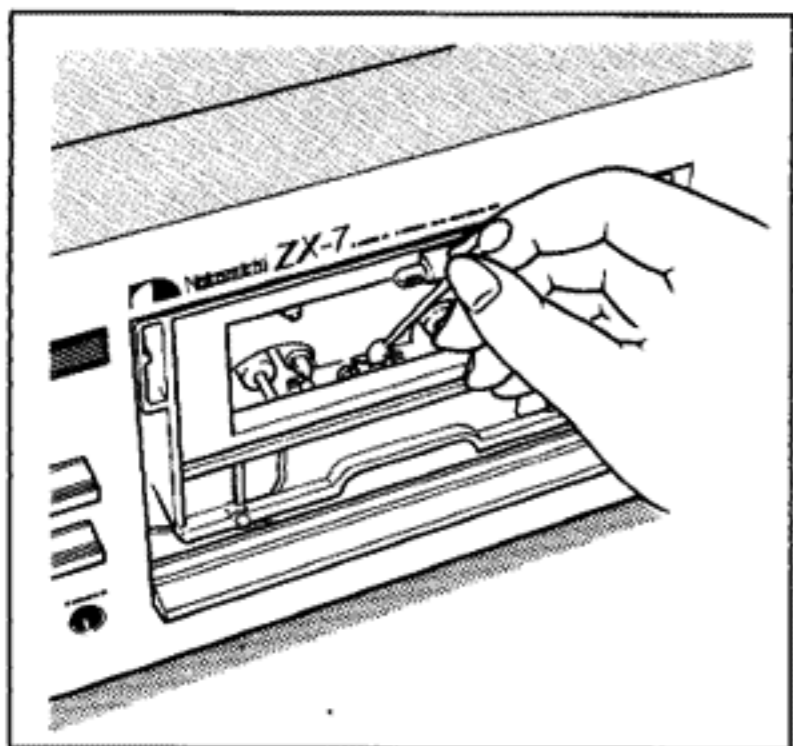

Cleaning should always be performed in the direction of the arrows in the chart (direction of tape travel).

Cleaning Procedure:

1. Remove the cassette holder cover.
2. Use the enclosed cotton-tipped sticks and—with very light pressure—clean the parts indicated in white on the illustration. In case of severe contamination, dip the cotton tip in the enclosed alcohol before cleaning, or use the enclosed plastic stick with a sponge tip screwed onto its end and dipped in alcohol.

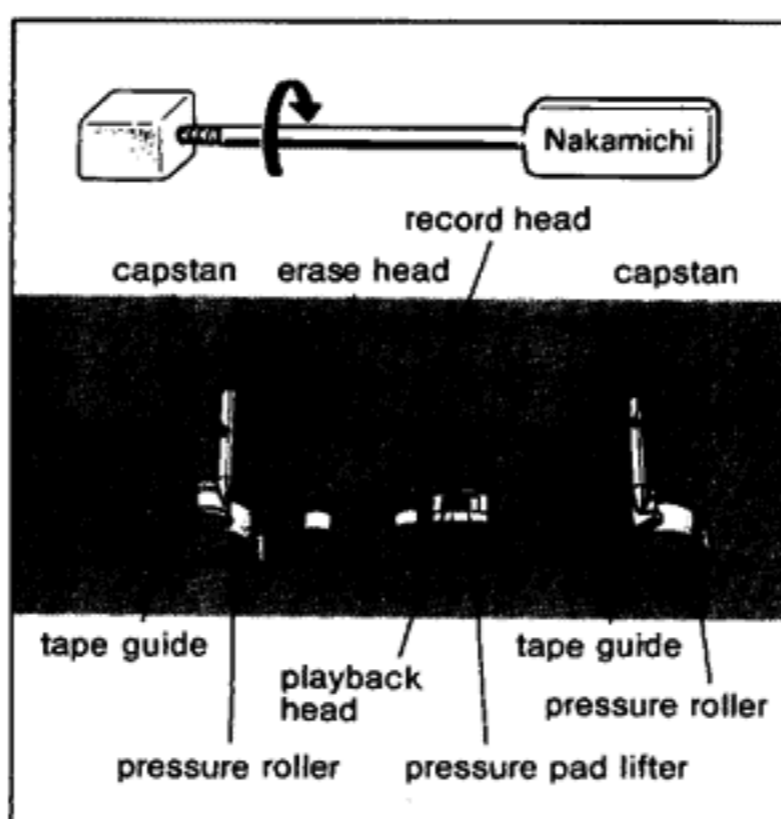

Note:

- To easily reach the various parts for cleaning, turn on the power to the deck and put the deck into the play-standby mode (play button and pause button depressed). The head assembly is now raised.
- Be careful not to apply too much force in cleaning, as the respective parts are critically aligned.
- When you have used alcohol in cleaning, give the cleaned surfaces a minute or two to dry off completely before playing a tape.
- Be careful not to damage the tape guides or the tape pad lifter.
- When you have used cotton-tipped sticks, be sure to remove any cotton strands from the cleaned parts.

Demagnetizing

After a longer period of use, there can be a build-up of residual magnetism in the playback head, record head and erase head. Such residual magnetism can induce noise and partially erase the high frequencies of a tape being played. To prevent this, you should demagnetize these parts about once every 50 hours of use with the Nakamichi DM-10 Demagnetizer (optional) or any other properly designed demagnetizer.

Note:

- Always switch off the power to the deck before starting the demagnetizing procedure.

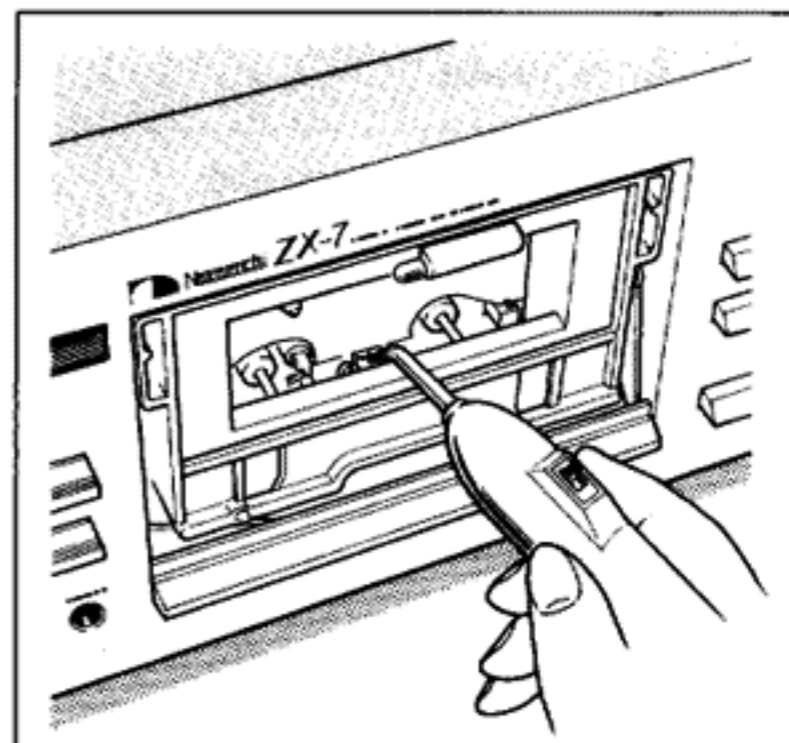

Cleaning the Faceplate

Clean the faceplate only by wiping it with the enclosed polishing cloth or another soft cloth. Never use alcohol, solvents, ammonia or abrasive cleaning agents.

Lubrication

All important moving parts of this deck are fitted with long-life, oil-less bearings. Periodic lubrication is therefore not necessary.

Troubleshooting

Condition	Probable Cause	Remedy
Tape does not run.	<ol style="list-style-type: none"> 1. Power cord is unplugged. 2. Cassette holder not firmly closed. 	<p>Plug in cord firmly.</p> <p>Press eject button and then close cassette holder firmly.</p>
Record mode cannot be entered.	<ol style="list-style-type: none"> 1. No cassette inserted. 2. Cassette tabs have been removed. 	Place adhesive tape over tab opening or use new cassette.
Excessive playback hiss.	Head is magnetized.	Demagnetize head.
Uneven sound levels, drop-outs, excessive wow/flutter	<ol style="list-style-type: none"> 1. Heads and/or capstans and pressure rollers dirty. 2. Faulty cassette. 	<p>Clean these parts.</p> <p>Replace cassette.</p>
Incomplete erasure.	Erase head dirty.	Clean head and pressure roller.
Distorted record/playback sound.	<ol style="list-style-type: none"> 1. Program material itself is distorted. 2. Recording levels are too high. 3. Excessive FM carrier leak. 4. Wrong tape selector button pushed. 	<p>Check program material.</p> <p>Wide dynamic range permits some short-term overload, but excessive recording levels will cause distortion. Adjust recording levels.</p> <p>Set the MPX filter switch to "On" when the Dolby system is used.</p> <p>Push the correct button for the tape in use.</p>
Record mode is entered, but cannot record.	<ol style="list-style-type: none"> 1. Input disconnected. 2. Head dirty. 3. Azimuth alignment button is set to on. 	<p>Check connections.</p> <p>Clean head.</p> <p>Release the button.</p>
Cannot playback.	<ol style="list-style-type: none"> 1. Output disconnected. 2. Head dirty. 	<p>Check connections.</p> <p>Clean head.</p>
Dull high frequencies.	<ol style="list-style-type: none"> 1. Heads dirty. 2. Tape selector buttons and/or equalizer switch not set correctly. 3. Bias amount does not fit tape in use. 4. Record head azimuth misalignment. 	<p>Clean heads.</p> <p>Select correct positions for tape in use.</p> <p>Perform bias adjustment.</p> <p>Perform azimuth alignment.</p>
Hum heard during recording or playback.	<ol style="list-style-type: none"> 1. Strong induction fields near deck. 2. Signal cable or connector grounding faulty. 	<p>Keep deck away from amplifier, transformers, fluorescent lamps, etc.</p> <p>Replace signal cables.</p>

Specifications

Track Configuration.....	4 tracks/2-channel stereo
Heads.....	3 (erase head x 1, record head x 1, playback head x 1)
Motors (Tape Transport).....	PLL servo motor (capstan drive x 1) DC motor (reel drive x 1)
Power Source.....	100, 120, 120/220-240, 220 or 240V AC; 50/60Hz (According to country of sale)
Power Consumption.....	40 W max.
Tape Speed.....	1-7/8 ips. (4.8 cm/sec.) \pm 0.5%
Wow-and-Flutter.....	Less than 0.08% Wtd peak Less than 0.04% Wtd rms
Frequency Response.....	20 Hz-21,000 Hz \pm 3 dB (recording level - 20 dB, ZX tape) 20 Hz-20,000 Hz \pm 3 dB (recording level - 20 dB, SX, EX II tape)
Signal-to-Noise Ratio.....	Dolby C-Type NR on <70μs, ZX tape> Better than 72 dB (400 Hz, 3% THD, IHF A-Wtd rms) Dolby B-Type NR on <70μs, ZX tape> Better than 66 dB (400 Hz, 3% THD, IHF A-Wtd rms)
Total Harmonic Distortion.....	Less than 0.8% (400 Hz, 0 dB, ZX tape) Less than 1.0% (400 Hz, 0 dB, SX, EX II tape)
Erasure.....	Better than 60 dB (100 Hz, 0 dB)
Separation.....	Better than 37 dB (1 kHz, 0 dB)
Crosstalk.....	Better than 60 dB (1 kHz, 0 dB)
Bias Frequency.....	105 kHz
Input (Line).....	50 mV, 70 k Ω
Output (Line).....	1V (400 Hz, 0 dB, output level control at max.), 2.2 k Ω
(Headphones).....	45 mW (400 Hz, 0 dB, output level control at max.) 8 Ω load
BlackBox Series DC Output.....	\pm 10 V, 125 mA max.
Dimensions.....	450(W) x 135(H) x 300(D) millimeters 17-3/4(W) x 5-5/16(H) x 11-13/16(D) inches
Approximate Weight.....	9.5 kg 21 lb.

- Specifications and appearance design are subject to change for further improvement without notice.
- Dolby NR under license from Dolby Laboratories Licensing Corporation.
- The word "DOLBY" and the Double-D-Symbol are trademarks of Dolby Laboratories Licensing Corporation.

Optional Accessories

ZX Cassette Tape C-60, C-90
SX Cassette Tape C-60, C-90
EX ■ Cassette Tape C-60, C-90
EX Cassette Tape C-60, C-90

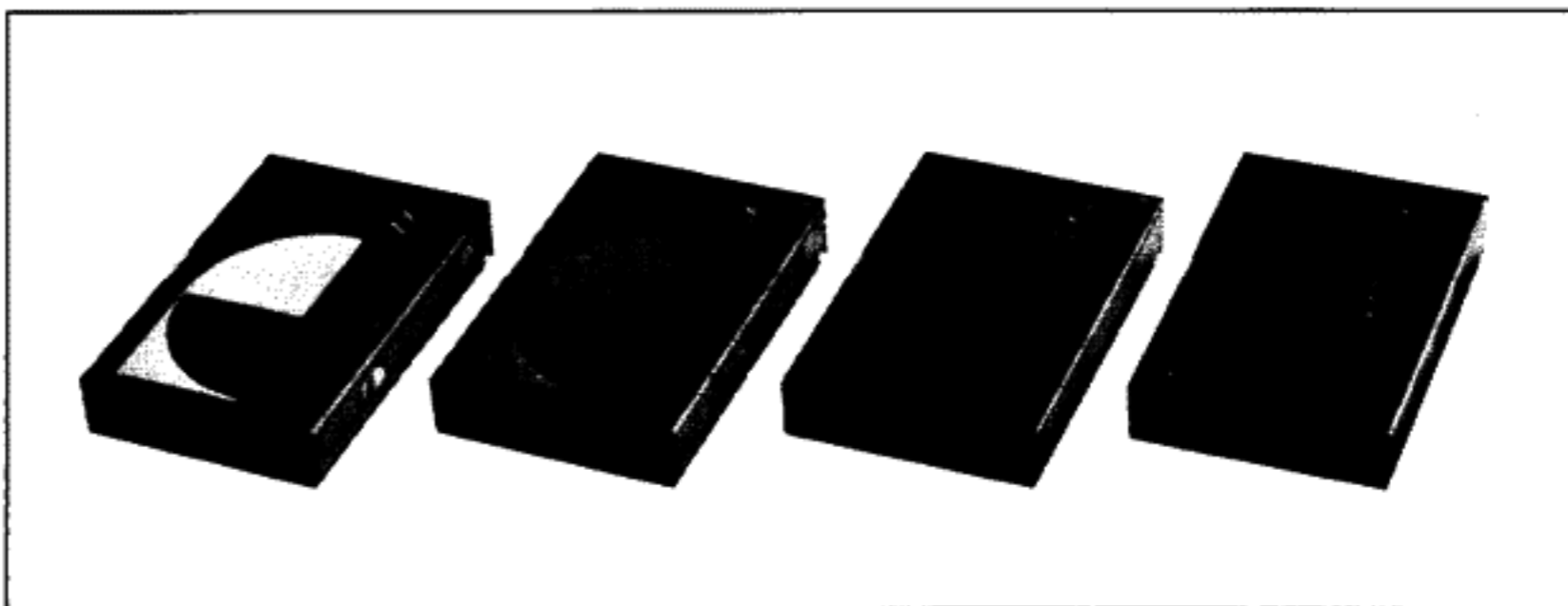

RM-200 Remote Control

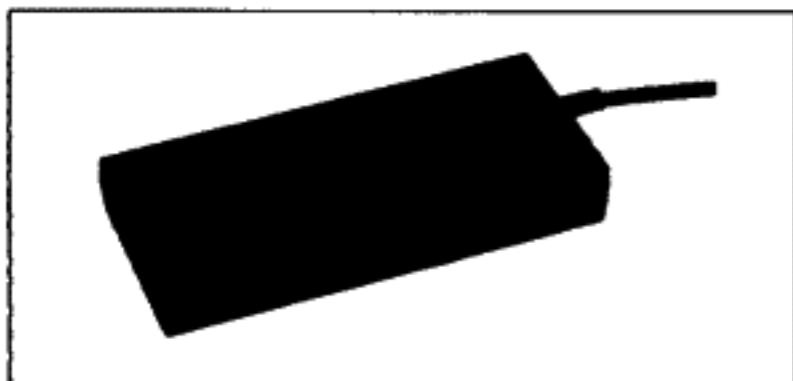

DM-10 Head Demagnetizer

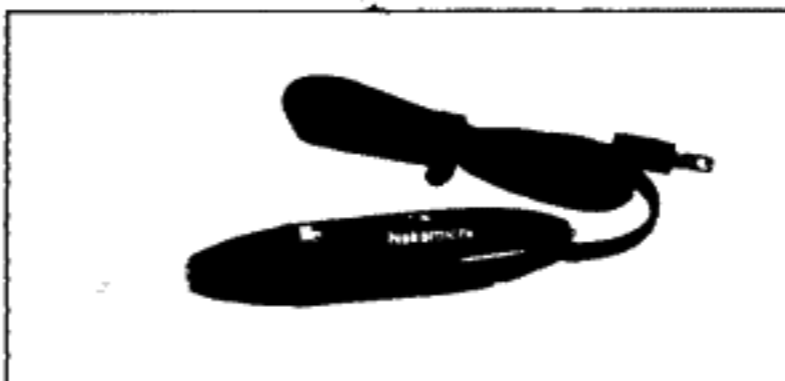

Nakamichi Corporation

Tokyo Office

Shinjuku Daiichi Seimei Bldg.

2-7-1 Nishishinjuku, Shinjuku-ku, Tokyo

Phone : (03) 342-4461

Telex : 2324721 (NAKAM J)

Nakamichi U.S.A. Corporation

1101 Colorado Avenue

Santa Monica, Calif. 90401

Phone : (213) 451-5901

Telex : 652429 (NAKREI SNM)

Nakamichi U.S.A. Corporation

220 Westbury Avenue

Carle Place, N.Y. 11514

Phone : (516) 333-5440